

Air conditioner control with IR blaster

Controlling standard Air-Conditioner with HIQ Home system

Block diagram

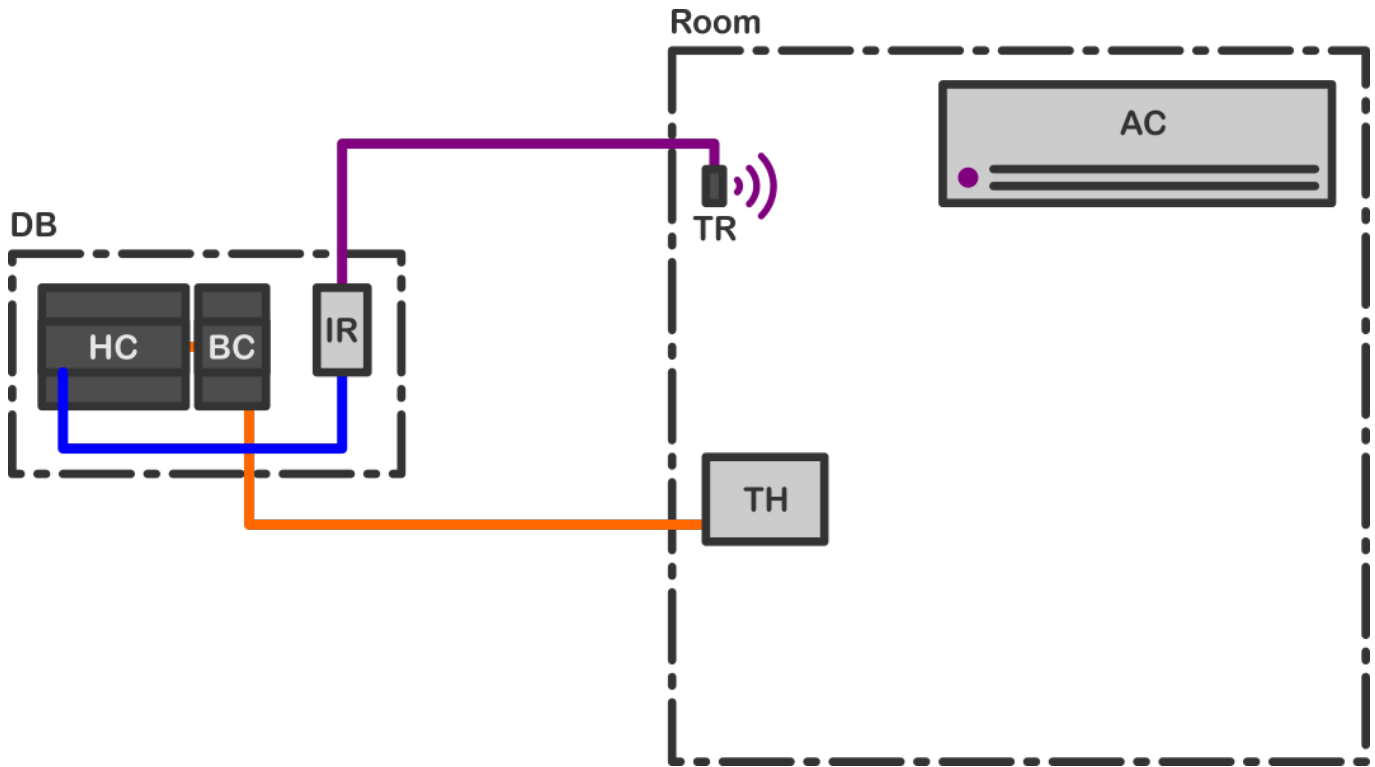

Legend	
DB	Distribution board
HC	HC-IQ
BC	CAD-BE-PROT-IQ
IR	IR-712A or IR-210 connected to HC-IQ COM1*
TR	IR transmitter connected to IR-712A or IR-210 IR Output
AC	Air Conditioner controlled with IR remote
TH	TH-1T-IQ or any HIQ thermostat
Remarks	
*	IR-712A supports up to 2 AC
	IR-210 supports up to 5 AC

Operation principle

As HIQ temperature regulation support fan-coils with 3 speed fan control, same principle is used for AC control. Instead of control valve and fan speed, system send IR commands as per following diagram.

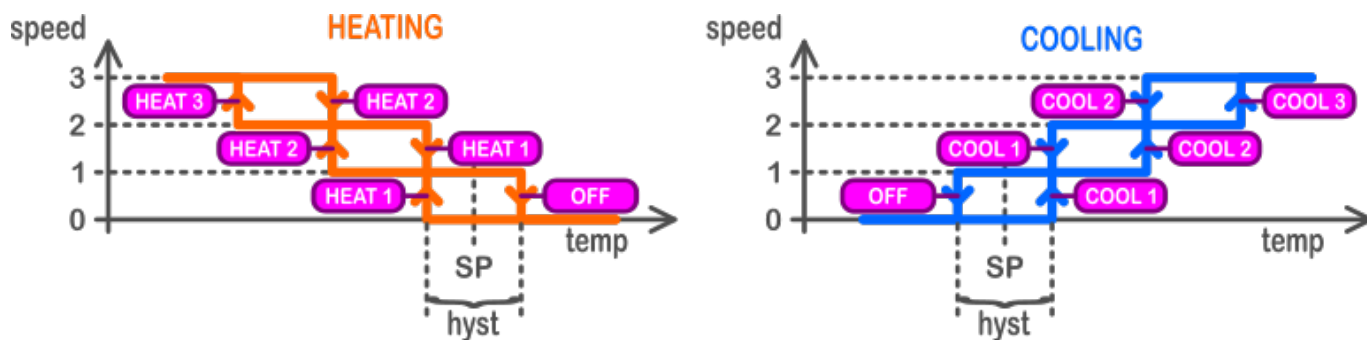

Depending on AC possibilities and user preferences different IR commands for HEAT 1-3 and COOL 1-3 can be used. In the following table there is an example for IR commands for Panasonic inverter AC.

command	AC remote setting			
	mode	setpoint	fan	air swing
OFF	OFF			
HEAT 1	HEAT	25°C	1/5	AUTO
HEAT 2	HEAT	25°C	2/5	AUTO
HEAT 3	HEAT	25°C	5/5	AUTO
COOL 1	COOL	18°C	1/5	AUTO
COOL 2	COOL	18°C	2/5	AUTO
COOL 3	COOL	18°C	5/5	AUTO

Startup

Prepare IR blaster

Setting communication parameters

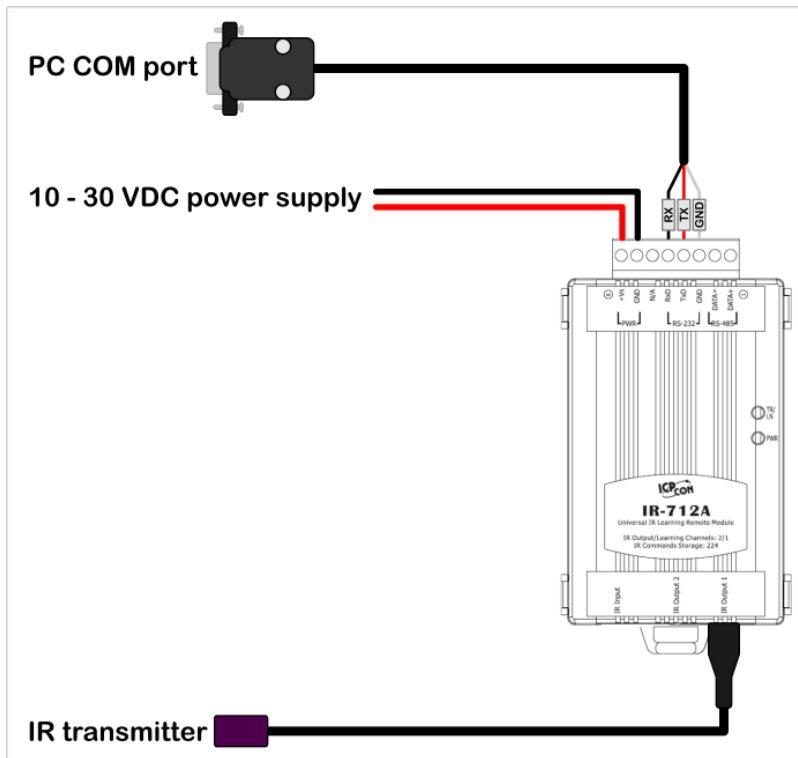

Connect IR blaster IR-712A or IR-210 to power supply and PC.

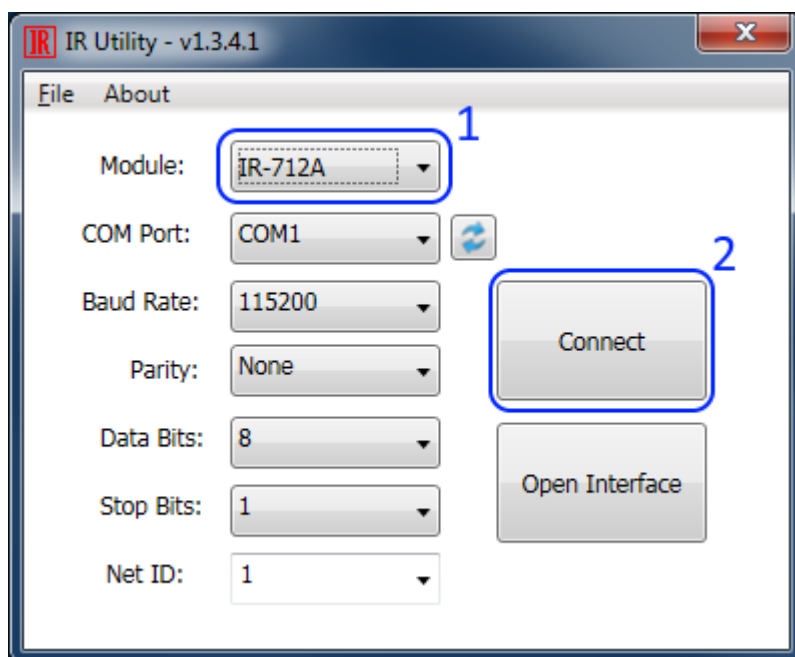

Open IR utility:

1. Select connected module
2. Press "Connect" button

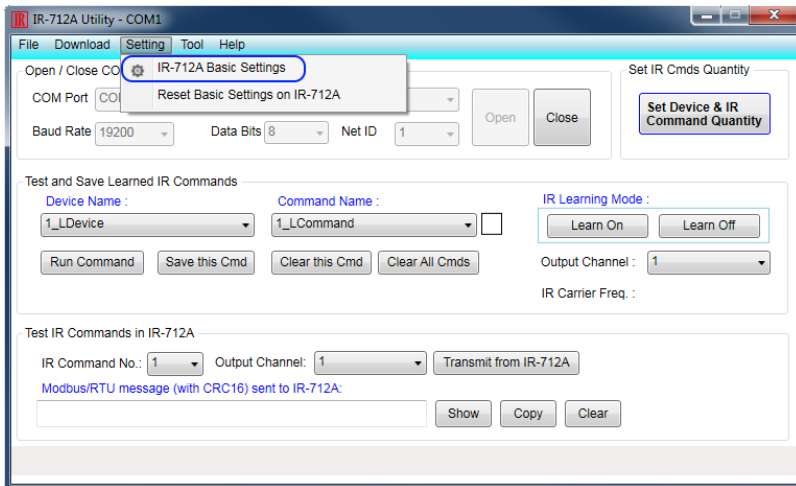

Go to “Settings” - “IR-712A Basic Settings”

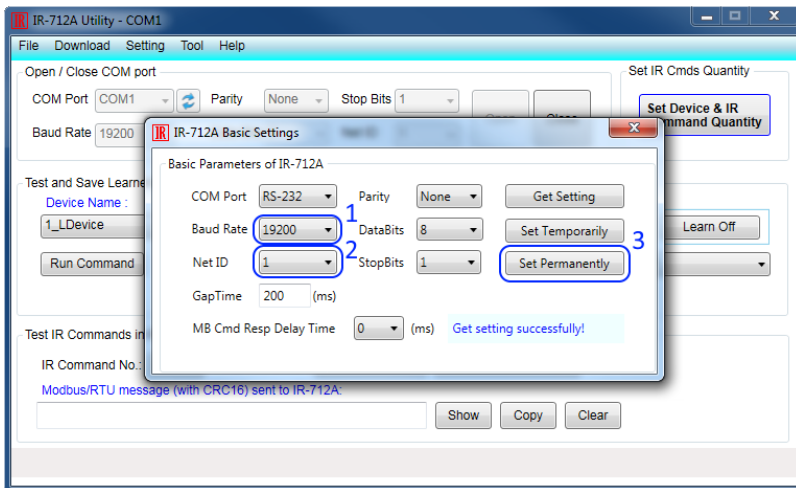

1. Set Baud Rate to 19200
2. Set Net ID (sequential numbers if more than one IR blaster is used)
3. Press “Set Permanently” button

IR commands set-up

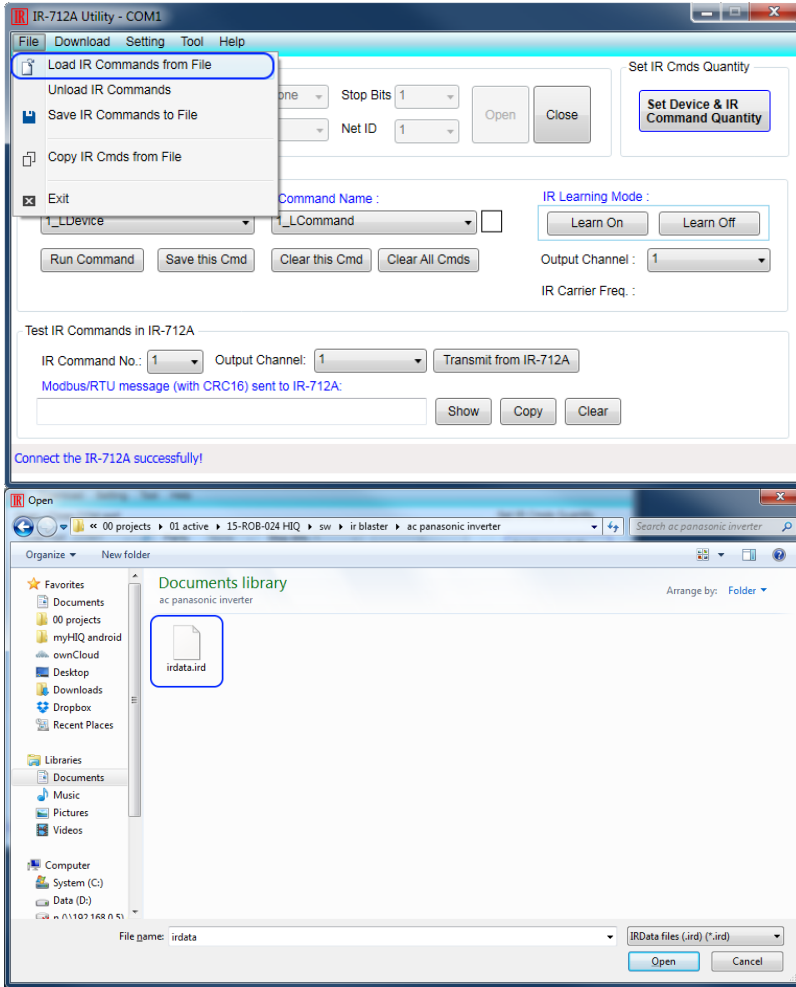

Download IR commands from file after AC and following commands:

[Download IR commands definition file:](#)

command	AC remote setting			
	mode	setpoint	fan	air swing
cmd1 - OFF	OFF			
cmd2 - HEAT 1	HEAT	25°C	1/5	AUTO
cmd3 - HEAT 2	HEAT	25°C	2/5	AUTO
cmd4 - HEAT 3	HEAT	25°C	5/5	AUTO
cmd5 - COOL 1	COOL	18°C	1/5	AUTO
cmd6 - COOL 2	COOL	18°C	2/5	AUTO
cmd7 - COOL 3	COOL	18°C	5/5	AUTO

Load IR from downloaded file.

If commands are not compatible with used AC or user needs are different from commands in file proceed to step 2, otherwise go to step 3.

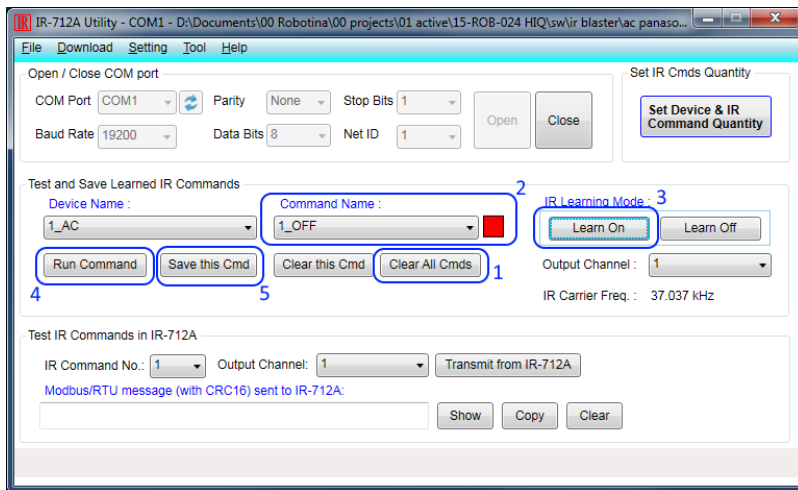

2. Learn new IR commands

1. Clear all commands.
2. Select which command to learn.
3. Press “Learn On” button. Prepare AC remote, aim IR remote transmitter to IR Input on AC blaster and press AC remote button which will send IR command to be learned.
4. Test learned command. If command is not working repeat from step 3.
5. Save IR command when it is working as expected.

Repeat steps 2-5 for all commands.

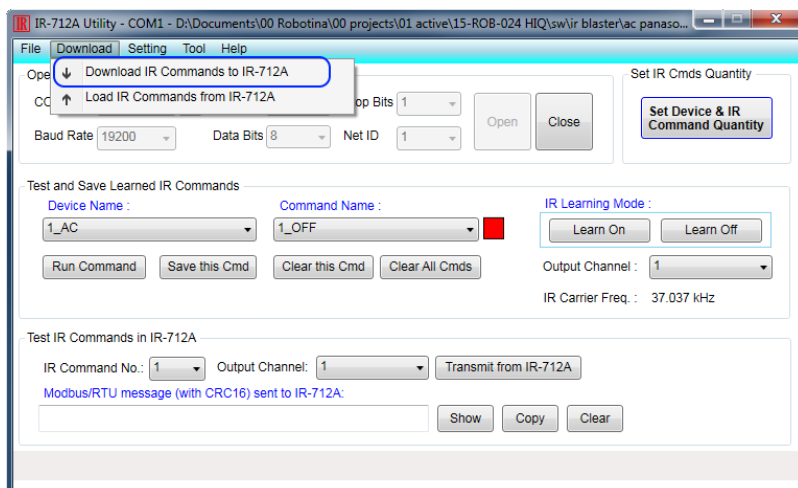

3. Download IR commands to IR blaster

Prepare HC-IQ

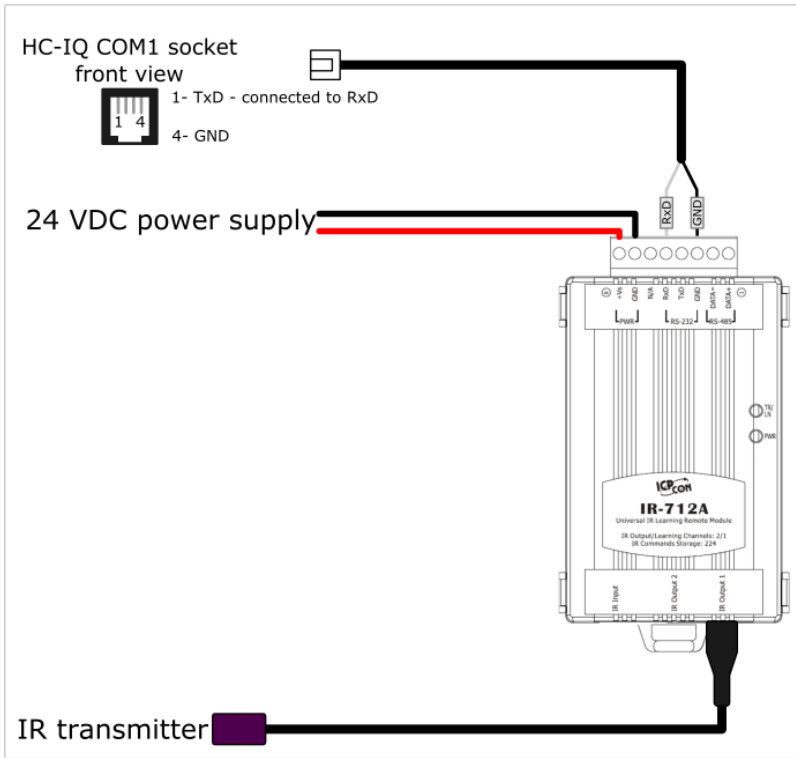

Connect IR blaster to HC-IQ

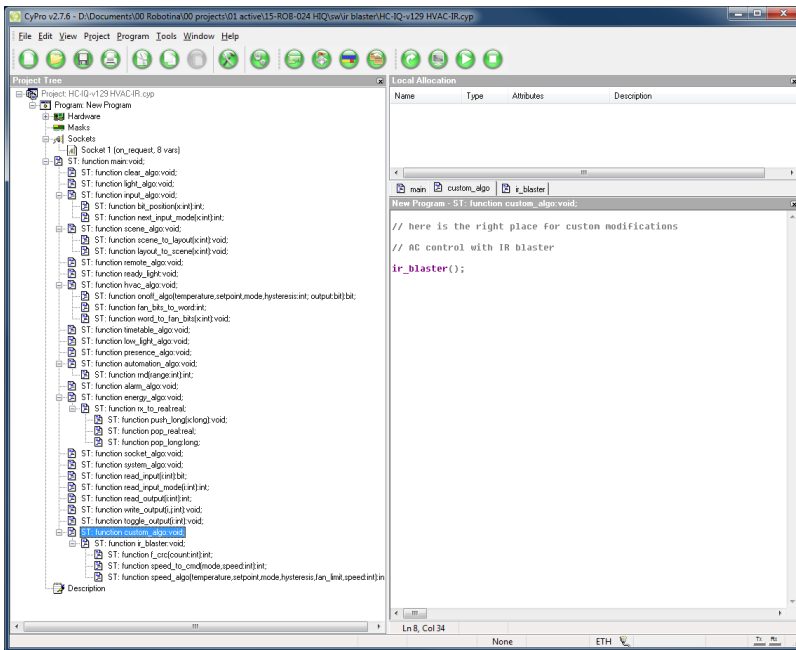

Downgrade HC-IQ project with integrated IR blaster to simple `ir_blaster()` function and all variables defined in `ir_blaster` group.

Send new project to your HC-IQ controller.

Resources

- IR-712A quick start

Last update:
2018/10/17
15:39

en:hiq_home:pralines:ir_blaster https://wiki.hiq-home.com/doku.php?id=en:hiq_home:pralines:ir_blaster&rev=1539790749

- IR-712A user manual
 - IR-210 quick start
 - IR.210 user manual
 - IR utility installation

From:

<https://wiki.hiq-home.com/> -

Permanent link:

https://wiki.hiq-home.com/doku.php?id=en:hiq_home:pralines:ir_blaster&rev=1539790749

Last update: **2018/10/17 15:39**

