

# Electric strike

## Electromechanical strike lock



<WRAP column 500px>

Model number:	<b>EL-ST</b>	Electric strike
Mounting:	Field, on door frame	

## General description

The most compact electric strike without sacrificing any of the quality or safety offered by our other products. EL-ST is the perfect match for narrow aluminium, PVC or timber profiles.

## Technical specifications

Power supply:	9-24V AC/DC, 12V DC
Continuos duty:	<1 min/ED 100%
Rated resistance:	43 Ohm
Current consumption AC:	0.15A...9V, 0.2A...12V, 0.39A...24V
Current consumption DC(stabilized):	0.21A...9V, 0.28A...12V, 0.56A...24V
Maximum side-load on AC:	24V - 200N
Maximum side-load on DC (stabilized):	12V - 50N
Break-in resistance:	4.800N
Dynamic strength:	4.400N
Endurance rating (cycles no side-load):	200.000
Complies with the directive:	2014/30/UE; 2011/65/UE

# Dimensions

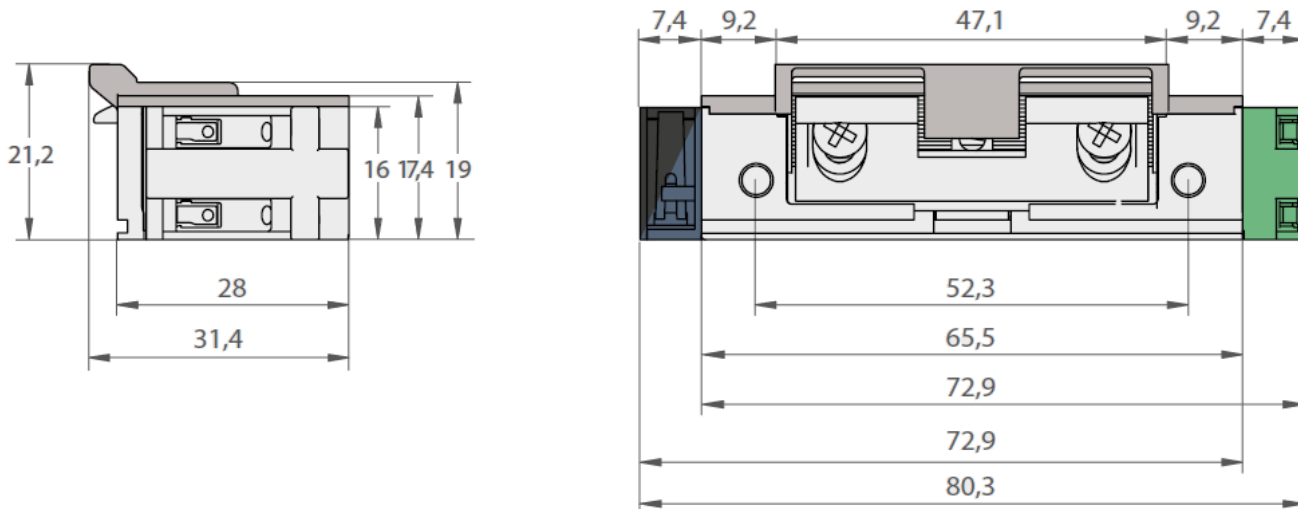

From:  
<http://wiki.hiq-home.com/> -

Permanent link:  
[http://wiki.hiq-home.com/doku.php?id=en:hiq\\_hw:el\\_strike&rev=1623320276](http://wiki.hiq-home.com/doku.php?id=en:hiq_hw:el_strike&rev=1623320276)

Last update: **2021/06/10 10:17**

