

Electric strike

Electromechanical strike lock

Model number: **EL-ST** Electric strike



General description

The most compact electric strike without sacrificing any of the quality or safety offered by our other products. EL-ST is the perfect match for narrow aluminium, PVC or timber profiles.

Technical specifications

Power supply:	9-24V AC/DC, 12V DC
Continuos duty:	<1 min/ED 100%
Rated resistance:	43 Ohm
Current consumption AC:	0.15A...9V, 0.2A...12V, 0.39A...24V
Current consumption DC(stabilized):	0.21A...9V, 0.28A...12V, 0.56A...24V
Maximum side-load on AC:	24V - 200N
Maximum side-load on DC (stabilized):	12V - 50N
Break-in resistance:	4.800N
Dynamic strength:	4.400N
Endurance rating (cycles no side-load):	200.000
Complies with the directive:	2014/30/UE; 2011/65/UE

Dimensions

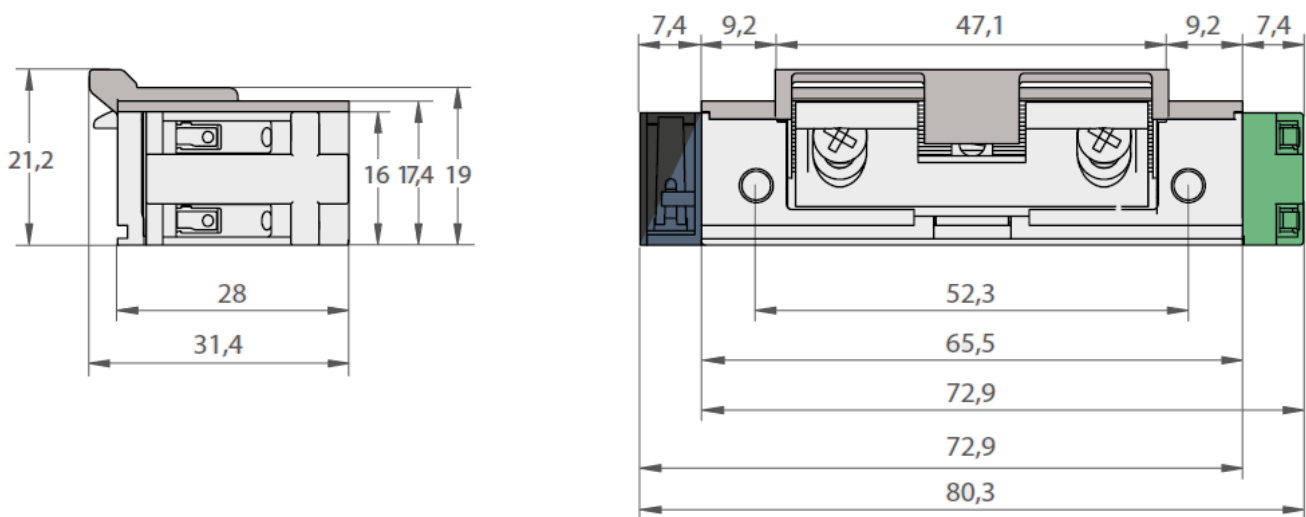

Terminals

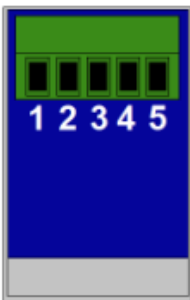
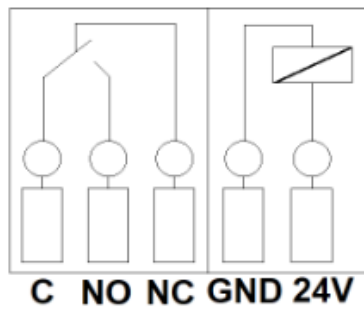

- 1 - 24V
- 2 - GND
- 3 - NC
- 4 - NO
- 5 - C

From:

<http://wiki.hiq-home.com/> -

Permanent link:

http://wiki.hiq-home.com/doku.php?id=en:hiq_hw:el_strike&rev=1623670626

Last update: **2021/06/14 11:37**

