

Three phase power sensor

3-phase power-sensor



Model number:	PM3-E-D
Connect to:	MC-230 RS485 power sensor bus A - B
Mounting:	DIN rail, 1M, 18 mm
Dimensions:	66 × 72 × 100 mm
Used for measuring power and energy of	
✓	single/three-phase energy sources
✓	single/three-phase energy consumers

Applications

- Digital multi-function power sensor for single/three phase networks

Features

- DIN rail mounting
- Three Phase 100A Direct Fed
- Accuracy Class 0.5 (Active Energy)
- Bi-directional Measurement for kW and kWh
- Configurable Pulsed output (Import/ Export/Nett kWh)
- Line Frequency
- Power, maximum power demand and power factor
- Active energy imported and exported
- Reactive energy imported and exported
- Supported Modbus (SDM630Modbus)

General description

SDM630 series measures and displays the characteristics of 1p2w, 3p3w and 3p4w supplies, including voltage, frequency, current, power, active and reactive energy, imported or exported, harmonic etc. Bi-directional measurement makes it an ideal choice for Solar PV measurement. The units support Max. 100A direct connection, saving the cost and avoiding the trouble to connect external CTs. Two pulse outputs and 1 communication port (Mbus/Modbus) are provided for remote monitoring. The unit has been approved to meet the requirements of EU Directive 2014/32/EU.

Technical specifications

Technical Data	
Operating Humidity	≤ 90%
Storage Humidity	≤ 95%
Operating Temperature	-25°C - +50°C
Storage Temperature	-40°C - +70°C
Mounting	DIN rail (DIN 43880)
Sealing	IP51 Indoor
Frequency	50Hz or 60Hz
Power Consumption	≤ 10W
Accuracy	
Voltage, Current	0.2% of range maximum
Frequency	0.1% of Mid-Frequency
Power Factor	1% of Unity (0.01)
Current transformer	
Frequency	50-60 Hz
Max current	100 A
Modbus	
Transmission Mode	RS485 Half-Duplex
Protocol	Modbus RTU
Baud Rate	2400bps - 38400bps
Address Range	1-247
Parity	EVEN/ODD/NONE
Data Bit	8
Stop Bit	1 or 2

Installation & Dimensions

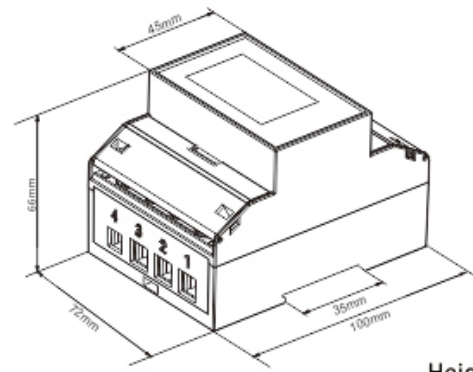
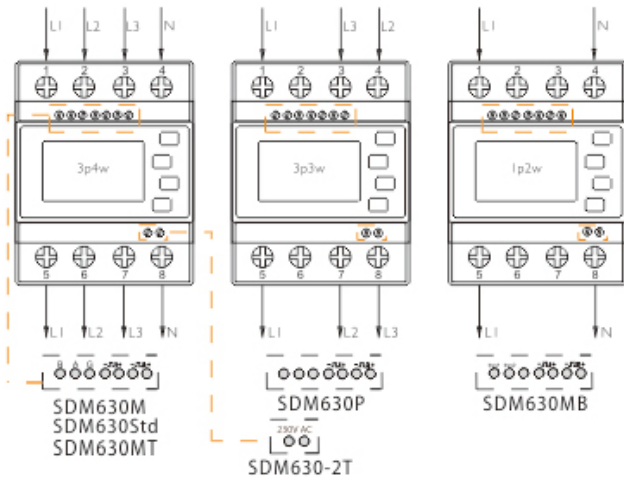

Height 100mm
Width 72mm
Depth 66mm

From:
<http://wiki.hiq-home.com/> -

Permanent link:
http://wiki.hiq-home.com/doku.php?id=en:hiq_hw:pm3-e-d&rev=1669993829

Last update: **2022/12/02 15:10**

