

Wireless Modbus-to-Modbus bridge

Wireless Modbus-to-Modbus bridge





Model number:	WM-1
Frequency:	ISM 868MHz (EU)
Dimensions:	93x45x27 mm

Applications

- Replacement for RS485 wiring solution with wireless. Optimal for long range Modbus RTU serial communications with half duplex configuration.

Installation and mounting

-  Carefully open WM-1 module and configure serial communication with jumpers. (Default configuration is 9600bps, 8N1 with normal timeout)
-  Place WM-1 module at least 10cm from other objects. Installation is not recommended inside metal cabinets.
- Connect RS485 terminals to WM-1 RS485 terminals
 - A - A
 - B - B
 - C - GND
- Connect to 230V power supply
- Configure radio pairing



Features

- replacement for RS485 wiring
- Modbus RTU serial protocol
- wired/wireless combinations
- very long range, no hopping
- protected private connection
- multiple slaves per device
- multiple addressable groups

Technical specification

Power supply:	230V, 50/60Hz, 1W
Ingress protection:	IP20
Operating temperature:	-20..50°C
Storage temperature:	-40..85°C
Relative humidity:	0..85% n/c

Terminals and wiring

To power sensor	A	RS485 bus
	B	
	C	
To power supply	L	230V AC
	N	

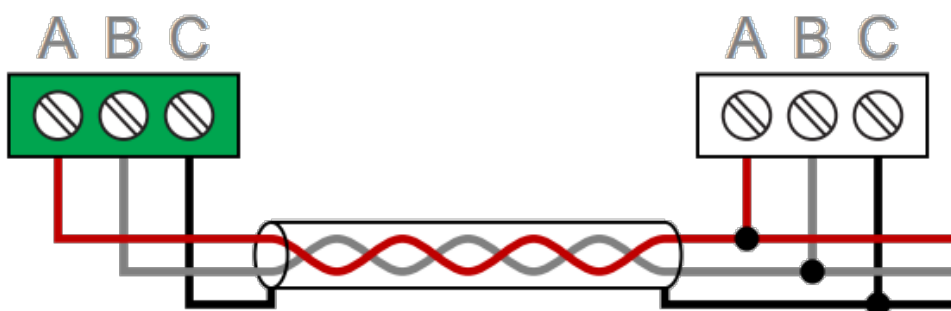

Serial configuration and timeout

- Available baudrates 2400, 9600, 19200, 38400 bps
- Data bits and parity 8N1, 7E1, 8E1, 8N2



- Max 64 bytes per transmission
- Integrated 240 Ohm termination resistor

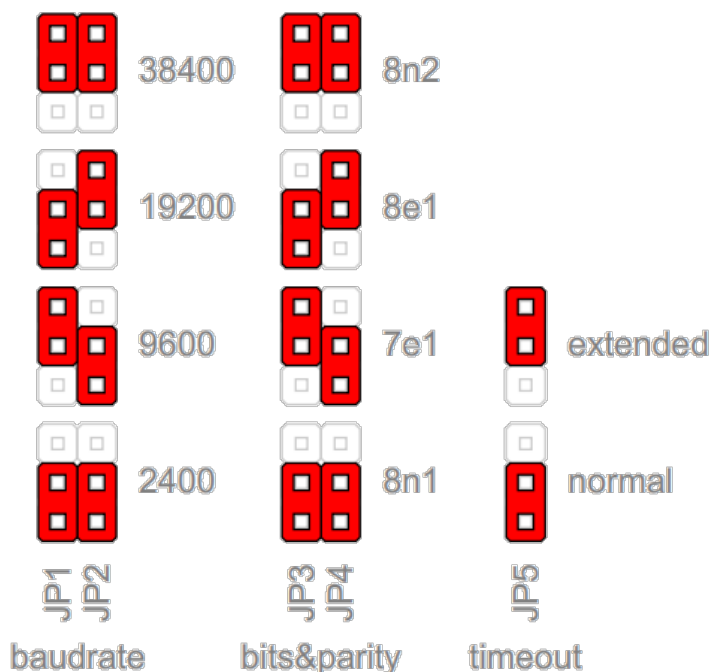

	normal	extended
2400	25ms	200ms
9600	10ms	100ms
19200	5ms	100ms
38400	5ms	100ms

Radio configuration

Create new secure group

- * turn on all devices as the same time
- * within 10 seconds, while RF LED is blinking, press and hold button on one of the devices
- * after a second, the new address is randomly generated and sent to all devices. RF LED will blink 3 times to confirm the new address.

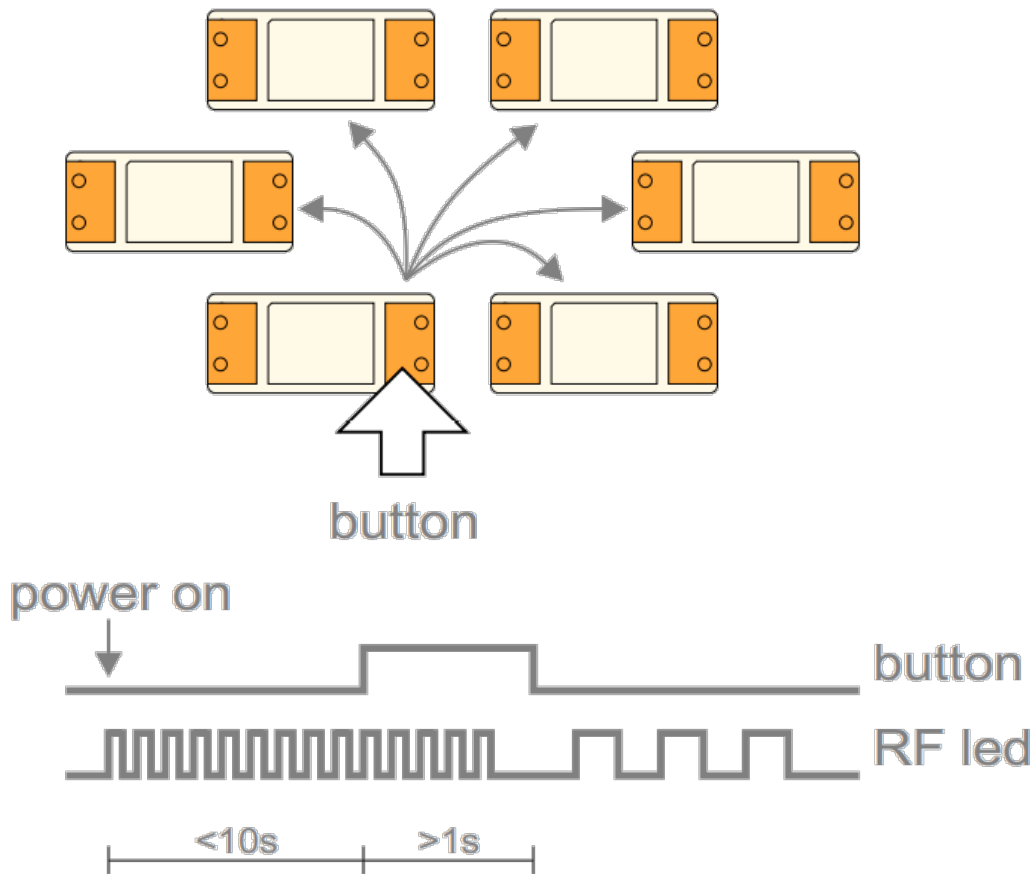

Add new device to the group

- * turn on the device
- * within 10 seconds, press and hold button on one of the existing devices
- * after a second, the existing group address is sent to the new device. RF LED will blink 3 times to confirm the address is sent.

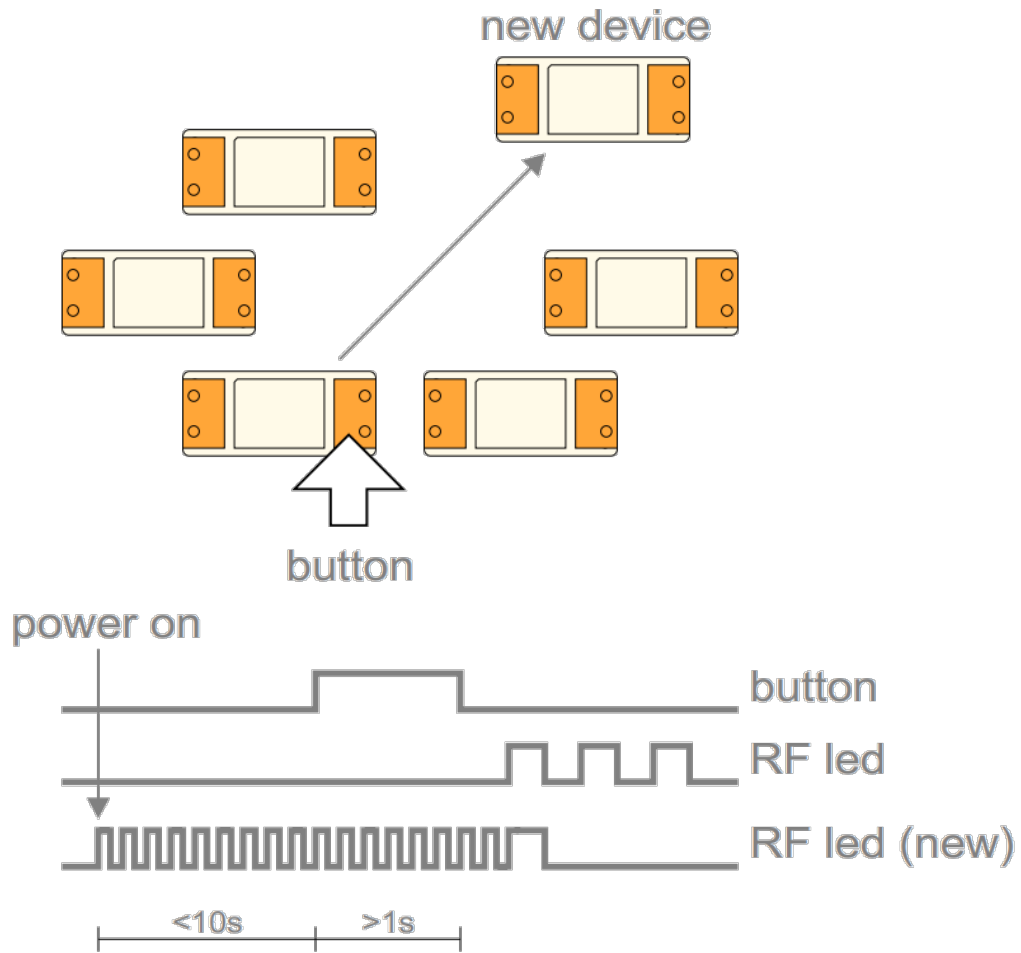

Topology examples

- * Modbus master, connected to 12 slaves using a pair of WM-1 devices
- * Modbus master, connected to 10 slaves, organized in two groups
- * Modbus master, connected to 5 slaves, each one having local WM-1 device

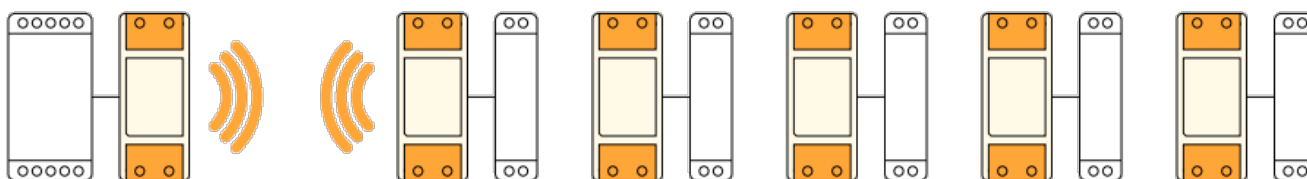
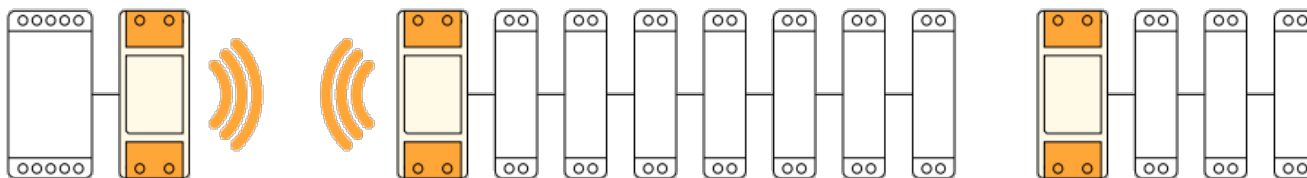
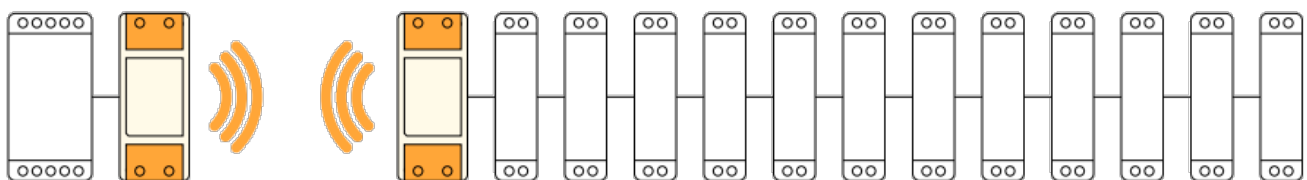

Multiple groups

- * When the system has two or more separate Modbus lines, they should be configured as separate groups.
- * Each group has a single master and one or more slaves.
- * Groups can't talk to each other, but they share the same bandwidth.
- * Two masters may start transmitting at the same time causing collisions.
- * To reduce number of missed messages, keep the traffic low.

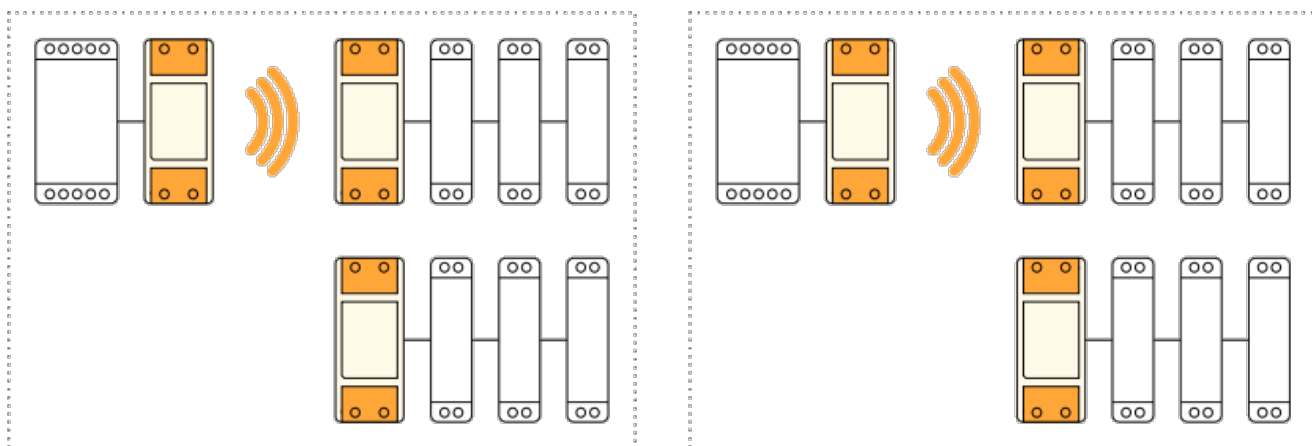

Connection check

- Press button shortly
- RF LED will blink shortly on each connected device

- Serial interface is unaffected

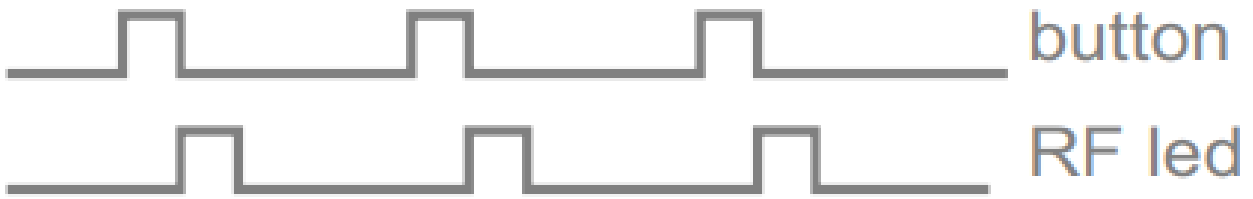

Factory reset

- Hold button and turn the device ON
- RF led will blink twice. Group address is now reset to default.
- Other devices will not be affected.

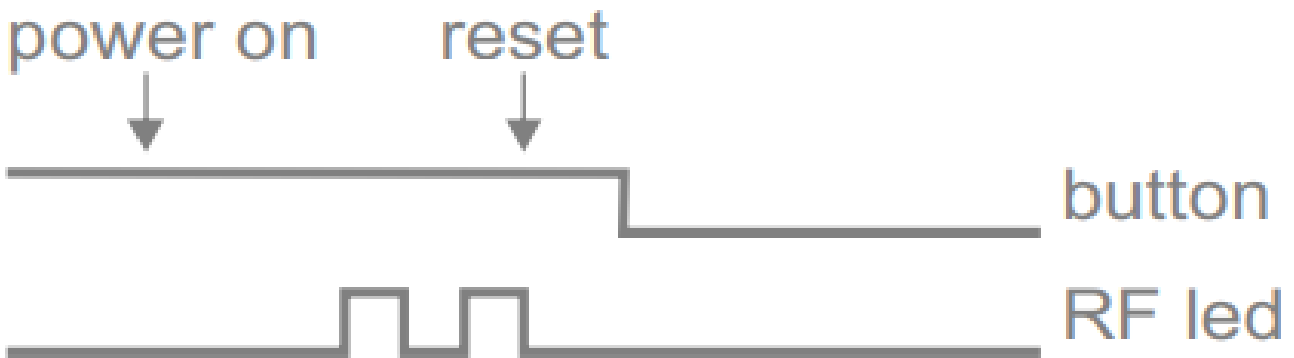

From:
<https://wiki.hiq-home.com/> -

Permanent link:
https://wiki.hiq-home.com/doku.php?id=en:hiq_hw:wm-1&rev=1634823565

Last update: **2021/10/21 13:39**

