

Master Controller

HIQ GRMS Master Controller

Model number:	MC-230-2
Mounting:	DIN rail, 6M, 106mm
Dimensions:	106x108x58mm

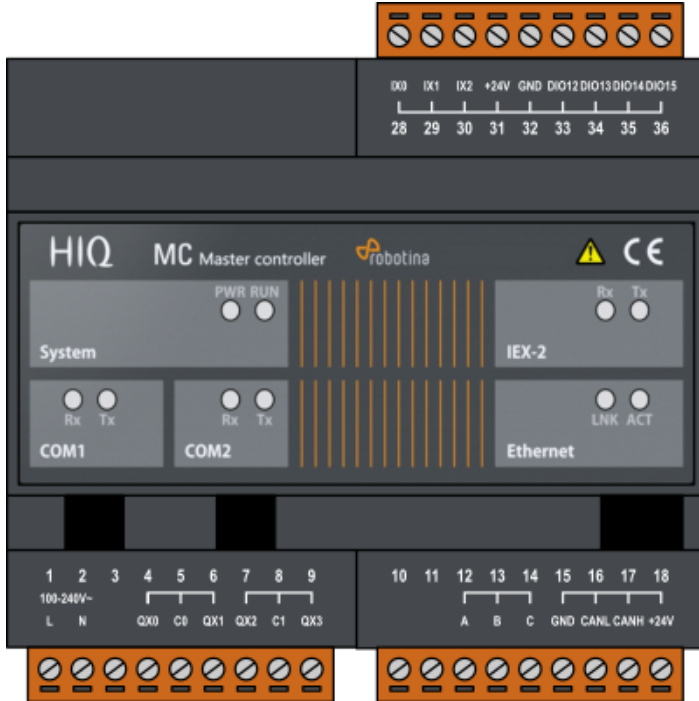

Features

- Master contactor
- Courtesy light
- 3 × ON/OFF lights
- 3 × dimmable lights
- HVAC
- Many optional functionalities

Safety standards

EN 50081-1, EN 61000-6-2, EN 61131-1, EN 61131-2, EN 61000-3-2, EN 61000-3-3

Technical specification

Relay outputs:	8A/250V
Communication:	Ethernet, 2x RS232, 1x RS485, IEX-2 bus
Nominal power rating:	110/230V (100-240VAC)
Power consumption:	typ. 1W (no load), 10W max
Power output:	24V 200mA (IEX-2 + terminals)
Ingress protection:	IP20
Operating temperature:	0..45°C
Storage temperature:	-20..75°C
Relative humidity:	0..95% n/c

Wiring

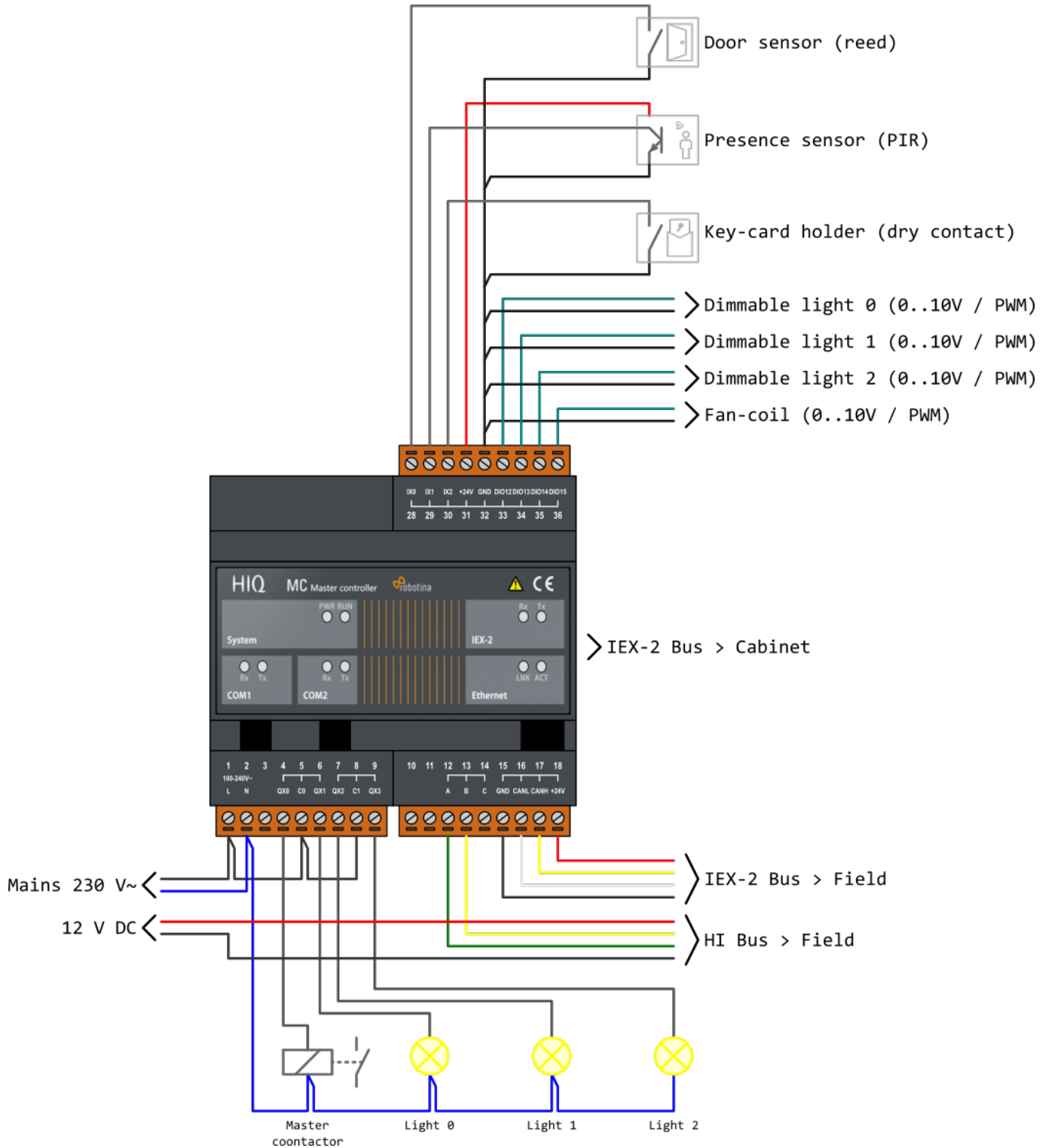

From:
<http://wiki.hiq-home.com/> -

Permanent link:
<http://wiki.hiq-home.com/doku.php?id=en:hotel:hardware:mc-230-2&rev=1543574144>

Last update: **2018/11/30 10:35**

