

Intelligent Master Controller

Monitoring Control gateway with MODBUS/TCP IP & OPC



Model number:	BM-C-A1
Description:	Battery Monitoring Master Controller
Mounting:	DIN rail, 6M, 106mm
Dimensions:	106x108x58mm

Features

- Industrial grade reliability
- Update & upgrade from Cloud
- Alarms & log
- One controller per UPS
- Max. 4 battery strings with one controller
- 4 outputs for battery disconnection/alarm
- Unlimited number of controllers in network
- Optional: Connection of temperature sensors (directly)
- Optional: Connection of temperature/humidity sensors (on bus)
- Optional: Connection of RFID/Digital key reader for confirmation of physical check by staff

Safety standards

EN 61010-1, EN 61010-2-201, EN 61131-2

Technical specification

Relay outputs:	8A/250V
Communication:	Ethernet, 2x RS232, 1x RS485, IEX-2 bus
Nominal power rating:	230 VAC
Power consumption:	typ. 1W (no load), 10W max
Power output:	24V 200mA (IEX-2 + terminals)
Ingress protection:	IP20
Operating temperature:	0..45°C
Storage temperature:	-20..75°C
Relative humidity:	0..95% n/c

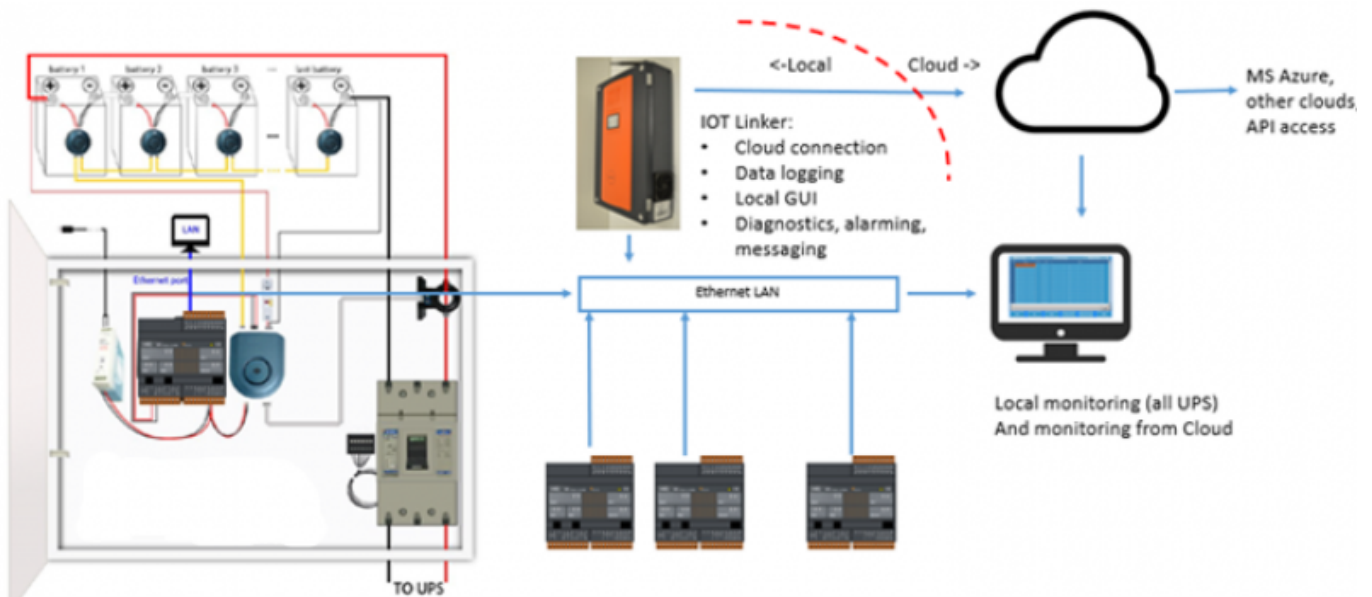

From: <http://wiki.hiq-home.com/> -

Permanent link: http://wiki.hiq-home.com/doku.php?id=en:ms_main:bm-c-a1&rev=1625046945

Last update: 2021/06/30 09:55

