

Motion sensor

Dual technology PIR/Ultrasonic motion detector ceiling recessed



Model number:	DIU-9-LC
Connects to:	digital input
Mounting:	Wall or ceiling

Applications

- Motion detector
- Ready light
- Lighting control
- Hotel GRMS

Installation instruction

- Ensure that there are no obstructions (plants, screens, furniture etc.) in the field of view that may cause incorrect cover/operation of the detector.
- Install the detector at proper height on a rigid surface. Do not install the detector on vibrating surface.

Technical specifications

Power supply	24 VDC
Current consumption	20mA
Temperature	-0°C ~ 55°C
Humidity	< 93% non condensing
Output contact rating	100,000 cycles @ 24 VDC, < 9mA
Range	9m US, 12m PIR(Adjustable)
Installing height	Max. 3.5 m
Detection	360 deg

Dimension

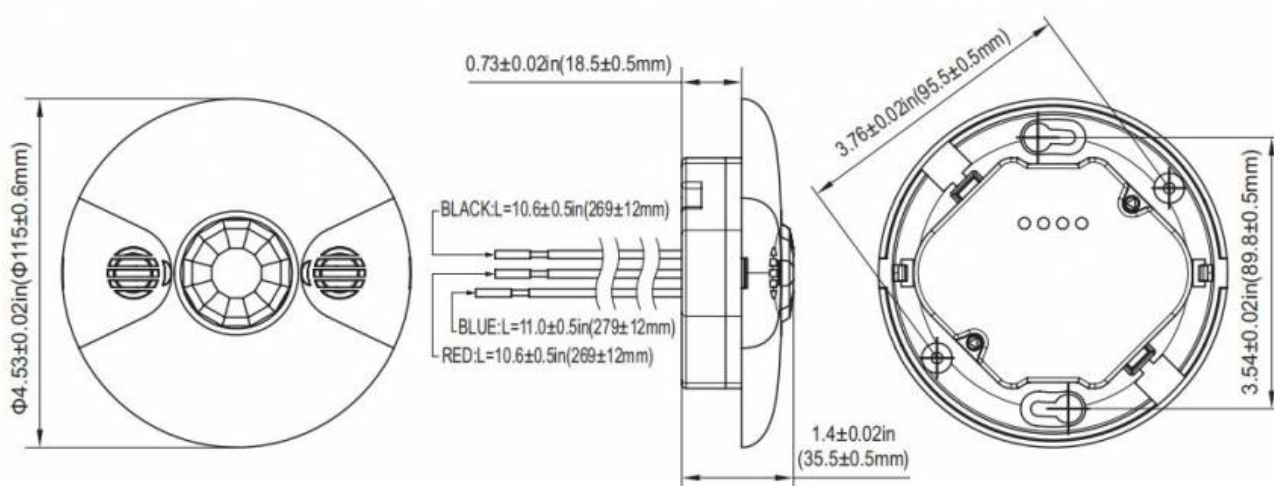

Range and detection pattern

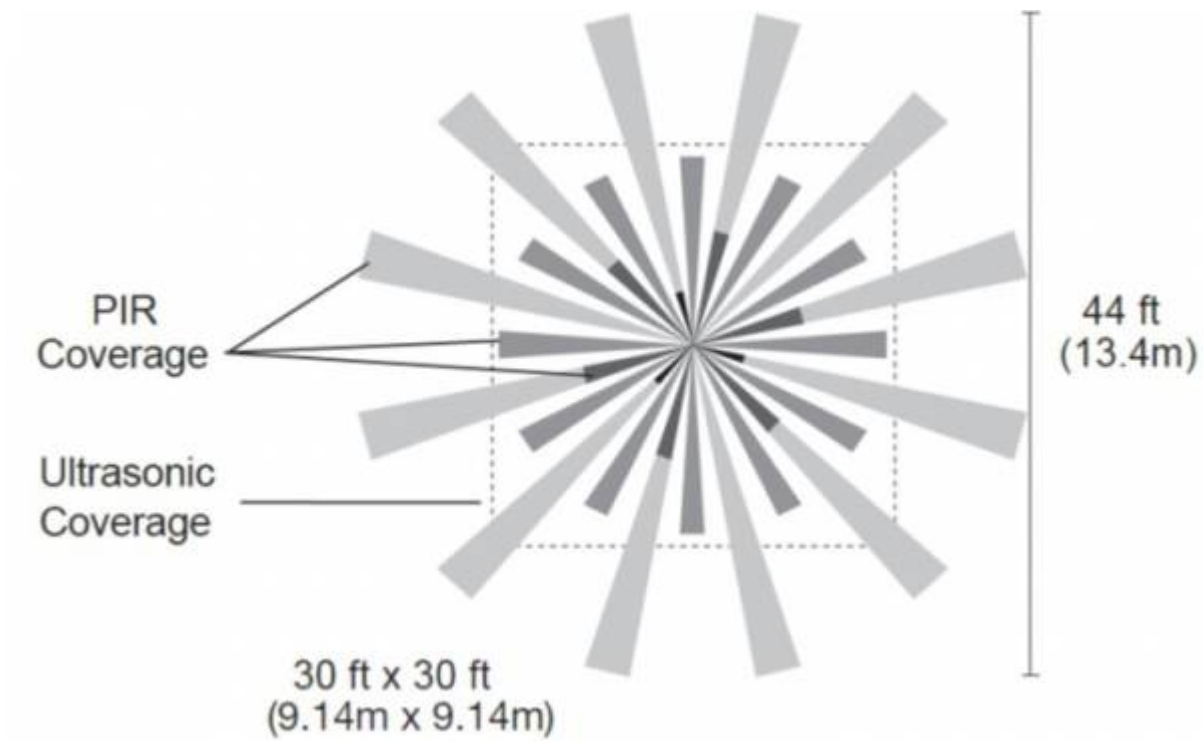

Mounting

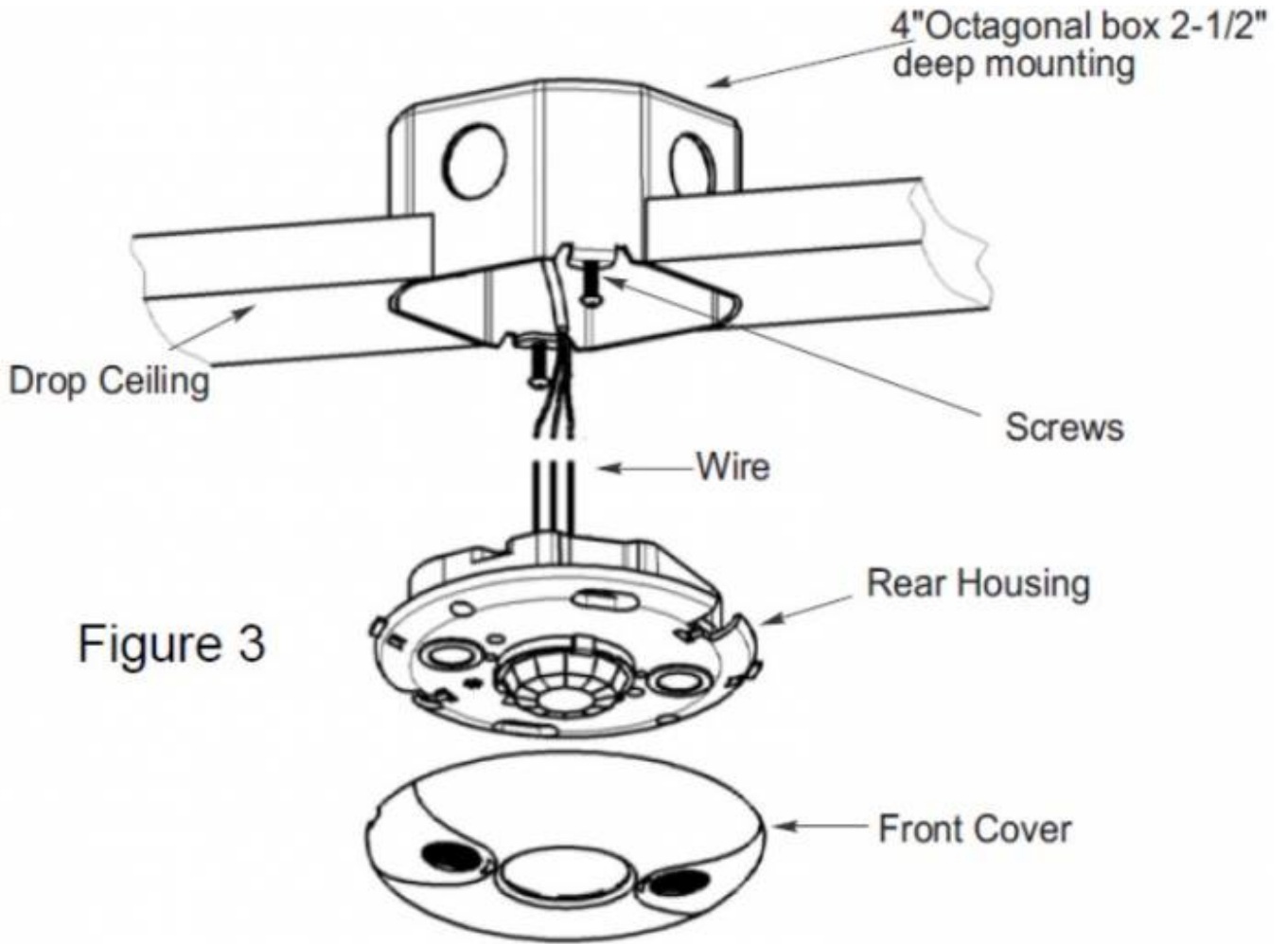

Terminals

Power supply	+ Red	Power supply
Common	- Black	
Signal	+ Blue	Output

From:
<http://wiki.hiq-home.com/> -

Permanent link:
http://wiki.hiq-home.com/doku.php?id=en:ms_main:diu-9-lc&rev=1591946375

Last update: **2020/06/12 07:19**

