

Motion sensor DALI with Lighting sensing

Passive infrared DALI detector with light sensing



Model number:	IR-A12DL-LC
Connects to:	DALI
Mounting:	On ceiling or wall
Dimensions:	95x95x45 mm

Applications

- Motion detector
- Ready light
- Lighting control
- GRMS

Features

- Aestetical look
- Easy mount
- Powered by DALI bus
- Lighting sensing
- High sensitivity PIR sensor

General description

A passive infrared detector on DALI system with lighting sensing.

Installation instruction

- Do not install the detector at position which faces direct or reflected sunlight or near windows with direct car headlight.
- Ensure that there are no obstructions (plants, screens, furniture etc.) in the field of view that may cause incorrect cover/operation of the detector.
- Avoid locating the detector in areas that contain equipment that may change the environment temperature rapidly (i.e. above radiator or under the air-conditioner)
- Install the detector at proper height on a rigid surface. Do not install the detector on vibrating surface.
- PIR detector is more sensitive to the motions “across” the detection zones than “toward” or “away”.

Range

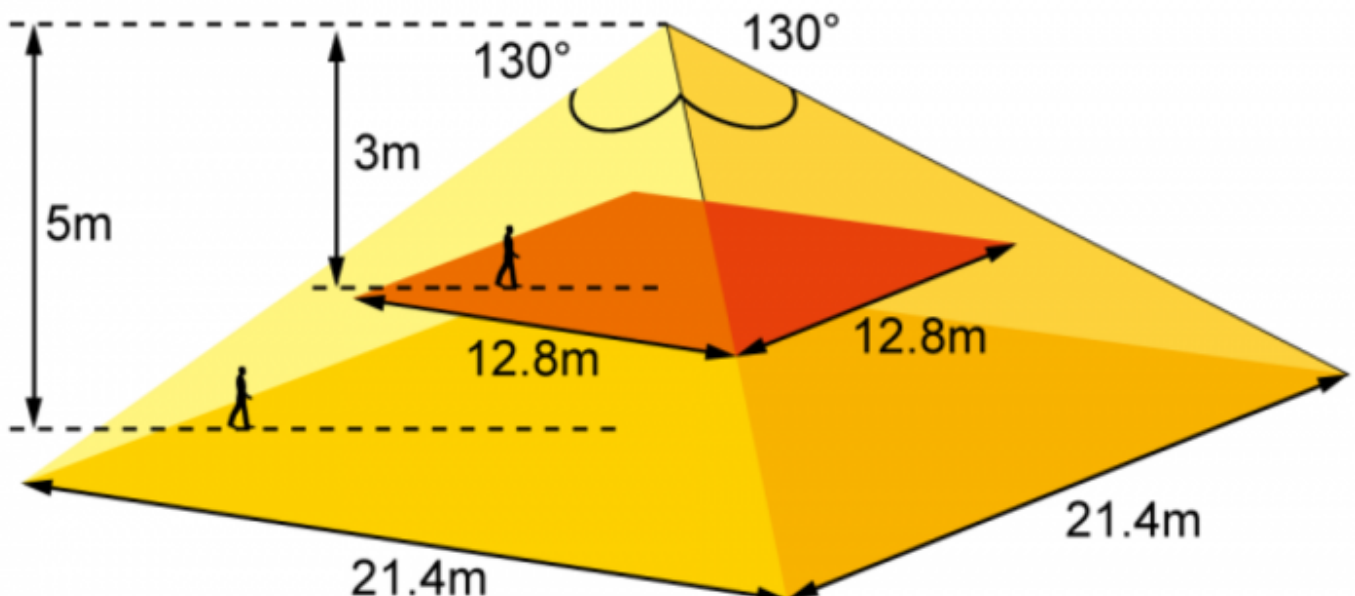

Technical specifications

Current draw	10 mA from DALI bus
Temperature	-20°C ~ +60°C
Operating humidity	10%-80% RH Non-Condensing
Connecting Wires	0.5~1.5 mm ² , solid or stranded wire
Weight	78.5g

Dimensions

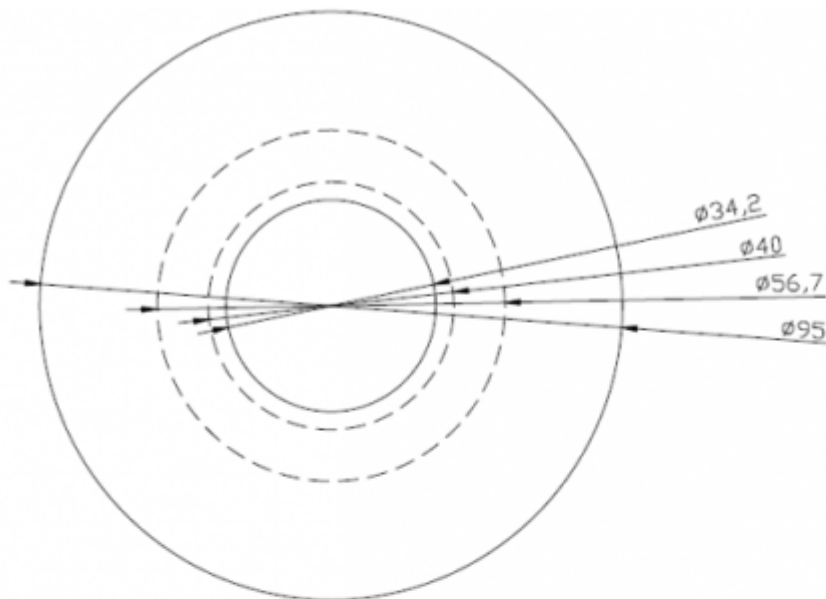

Diameter size diagram

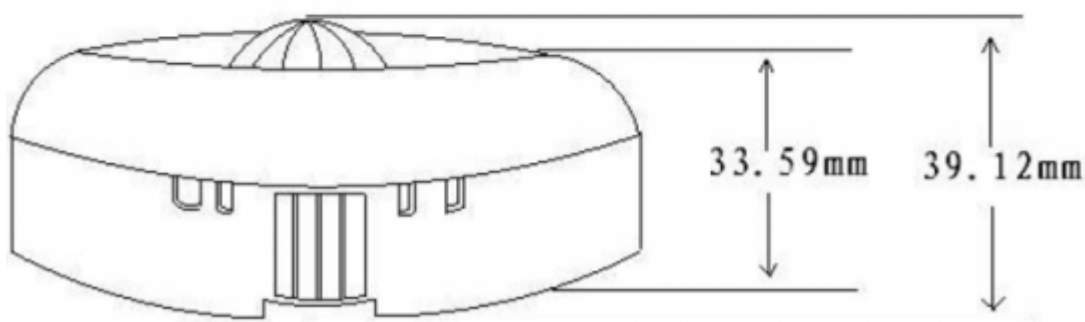

Side height sizes

Terminals

DALI +
DALI -

Installation

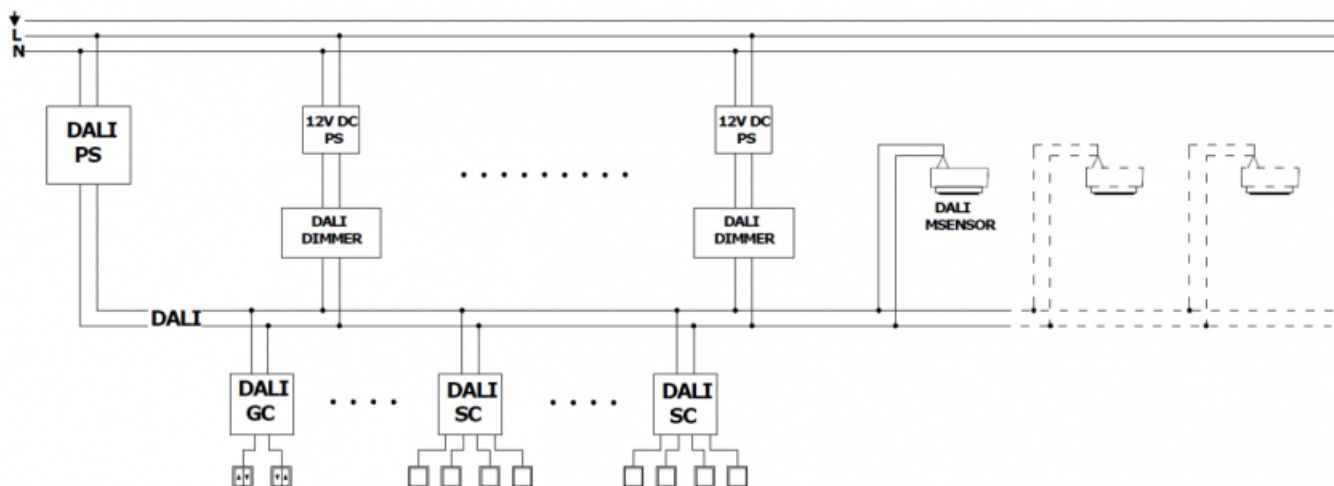

Settings

1	2	MODE
on	off	PIR
off	on	CDS
on	on	PIR&CDS
off	off	Disable

Group Selector Position rotating switch	Light Group	PIR Group
0	Broadcast	1
1	1	2
2	2	3
3...9	3...9	4...10
A...F	10...15	11...16

From:
<http://wiki.hiq-home.com/> -

Permanent link:
http://wiki.hiq-home.com/doku.php?id=en:ms_main:ir-a12dl-lc&rev=1606138038

Last update: **2020/11/23 13:27**

