

Robotina Charger wiring

Network
Default connection to the LAN network:
<input type="checkbox"/>
Default connection via LTE 4G modem:
NOTE: All connected devices will have internet access via LTE modem which can result in high costs on your LTE account.
<input type="checkbox"/>
Optional LTE 4G modem connection:
<input type="checkbox"/>
Wireless power sensors
Single phase power-sensor PM1-E-D
<input type="checkbox"/>

Single phase power-sensor with current transformer [PM1-E-D-CT](#)



3-phase power-sensor [PM3-E-D](#)



3-phase power-sensor with current transformer [PM3-E-D-CT](#)



Charger and wireless power sensors.

One or more [WM-1](#) modules can be used. One or more power sensors can be connected to one [WM-1](#).



Power-sensors orientation

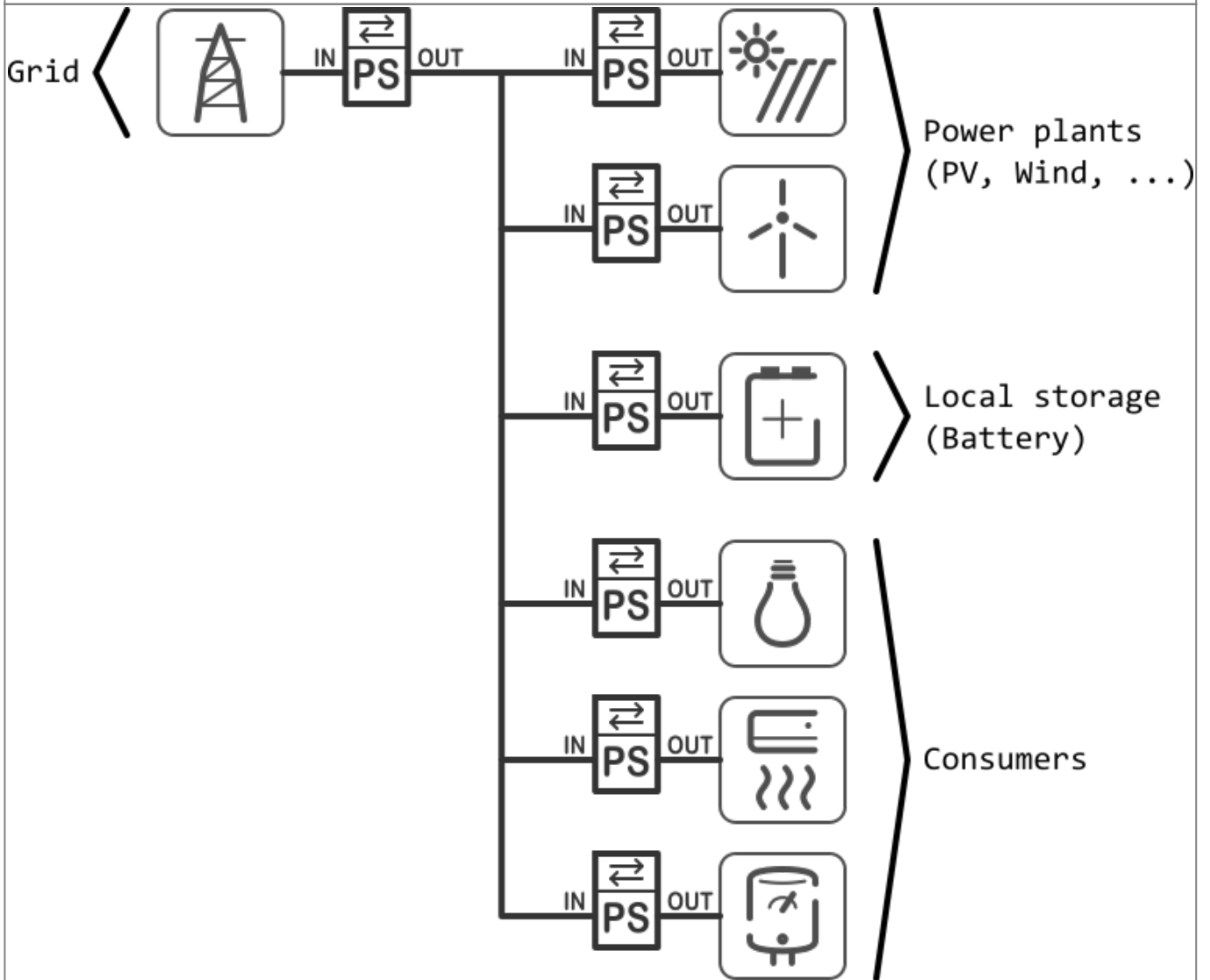

From: <http://wiki.hiq-home.com/> -

Permanent link: http://wiki.hiq-home.com/doku.php?id=en:robotina_charger:wiring&rev=1670506582

Last update: **2022/12/08 13:36**

