

GSM-SA User Manual

rev. 1.03

mobile device to remotely control your home

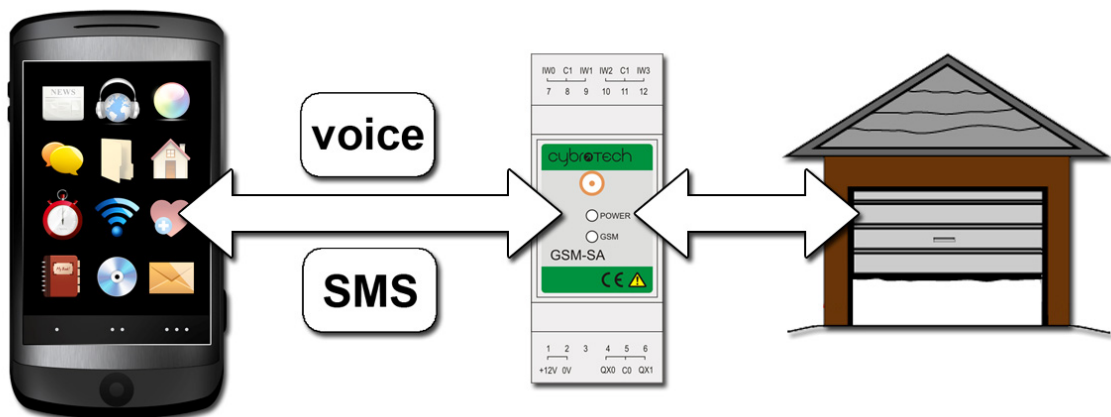







Index

Index.....	1
Description	2
Commands.....	3
Read inputs by message	3
Activate relay by message.....	3
Activate relay by incoming call.....	4
Outgoing alarm message.....	4
Outgoing alarm call	6
Phone authorization	6
Settings and status	7
Applications.....	8
Call garage to open door for you	8
Activate heating before arriving to cottage	8
Secure your property against burglary.....	9
Water level monitoring and alarm	9
Specifications	10
Wiring.....	10
Mounting	10
Master reset	10



Description

GSM-SA stand-alone modem provides the following functions:

-  activate relay by a call (free of charge, call is denied)
-  activate relay by a message
-  call predefined number when condition is met
-  send alarm message to predefined number when condition is met
-  read analog/binary inputs by a message
-  authorize users and read status by a message

Hardware:

- internal GSM antenna
- connector for external antenna (SMA type), automatic switch
- 4 analog/digital inputs, 2 relay outputs

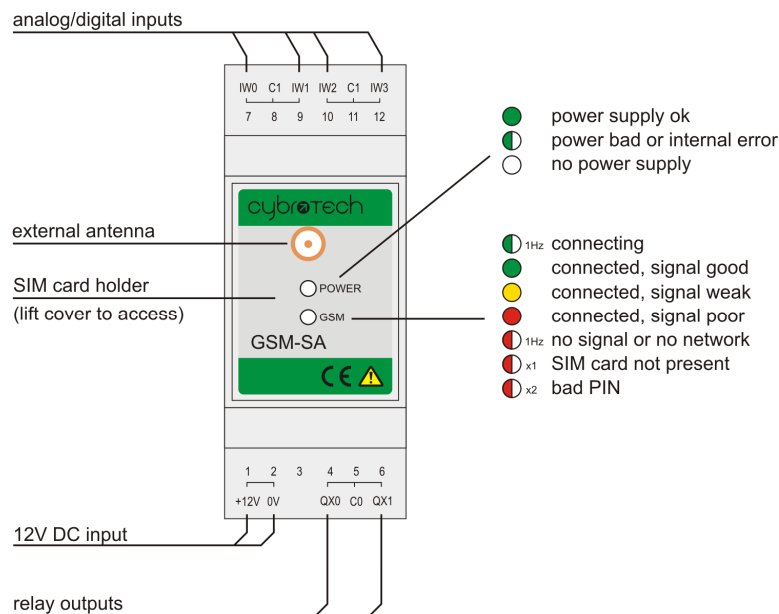

Before inserting SIM card, make sure PIN is deactivated. To do so, enter SIM card into your phone, open Settings, Security, PIN code request, and set to off. Turn phone off, remove SIM and put to GSM-1 module. The similar procedure may be used to renew prepaid account.

To insert SIM card, use small screwdriver to lift cover, insert card, then gently push cover back until you hear click.

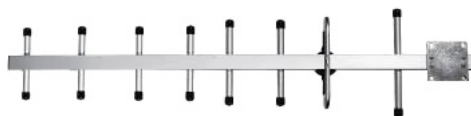

When using on remote locations, where GSM signal is weak, it is recommended to use external antenna. If multi-band antenna is not enough, better results may be obtained with directional yagi, lifted few meters on a pole. Look for 12dB gain or more, and take care to find the best orientation.

Commands

Send command using SMS message (standard text, not multimedia or e-mail). Module will send a reply soon. Multiple commands are separated by space.

Read inputs by message



ix0, ix1, ix2, ix3 - binary inputs, 0-open, 1-closed
iw0, iw1, iw2, iw3 - analog inputs, for 0..10V readout is 0..1023

```
send: ix0=? ix1=? iw2=? iw3=?  
reply: ix0=0 ix1=1 iw2=430 iw3=600
```

Example:

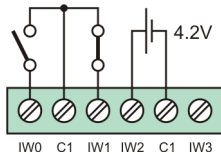

Binary and analog inputs share same terminal. Iw0 is open (ix0=0), iw1 is closed (ix1=1). Iw2 voltage is 4.2V, so readout is $4.2V \div 10V \times 1023 = 430$. Iw3 is open, pull-up drives it to approximately $6V \div 10V \times 1023 \approx 600$.

Commands are not case-sensitive, both small and capital letters may be used.

Activate relay by message



qx0, qx1 - relay outputs, 0-off, 1-on

```
send: qx0=1  
reply: qx0=1 ok
```

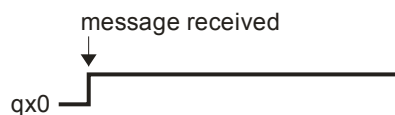

Relay 0 is now on.

qx0b, qx1b - controls external bistable relay, 0-off, 1-on, depending on feedback contact connected to ix0/ix1

```
send: qx0b=1  
reply: qx0b=1 ok
```

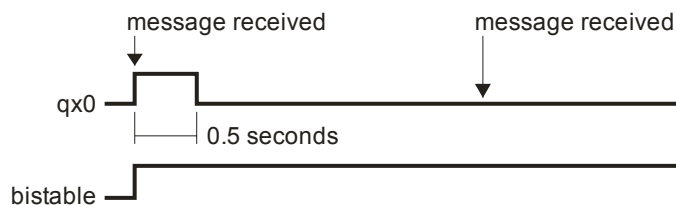

Relay 0 is connected to bistable coil, input ix0 to bistable auxiliary (feedback) contact. Bistable relay toggles when coil is energized. Suitable relay is Schrack LQ612230.

If bistable is off (ix0=0), qx0b=1 will make a pulse on qx0 to turn it on. If bistable is already on (ix0=1), nothing will happen. Likewise, if bistable is on, qx0b=0 will pulse qx0 to turn it off, and output nothing if it is already off.

Reply message returns the actual state of ix0 input, therefore actual state of bistable. Pulse length is 500ms, not related to "pulse" setting.

qx0p, qx1p - pulse output for a specified time

send: qx0p
reply: qx0p ok

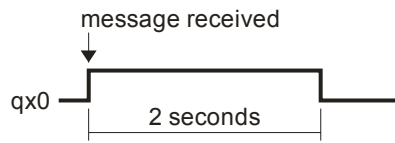

Relay is unconditionally activated for 2 seconds. If already set, it will go off after specified time.

pulse - pulse length (default is 2) [seconds]

send: pulse=10
reply: pulse=10 ok

Configure pulse length to 10 seconds.

Activate relay by incoming call



voicecall - select action to perform when voice call is received (default is no action):

1	qx0=1	2	qx1=1
4	qx0=0	8	qx1=0
16	qx0b=1	32	qx1b=1
64	qx0b=0	128	qx1b=0
256	qx0 pulse	512	qx1 pulse
1024	send status	2048	call back

send: voicecall=256
reply: voicecall=256 ok

When call is received, relay qx0 will go on for a predefined time (defined by pulse command):

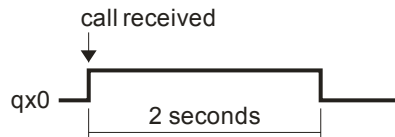

To perform actions simultaneously, add up numbers (e.g. with voicecall=3, call will activate both qx0 and qx1).

Outgoing alarm message



Each input may trigger one alarm message. Message is sent when contact is closed, open, or both ways. Similarly, analog input may send a message when value exceeds high limit, lo limit, or both.

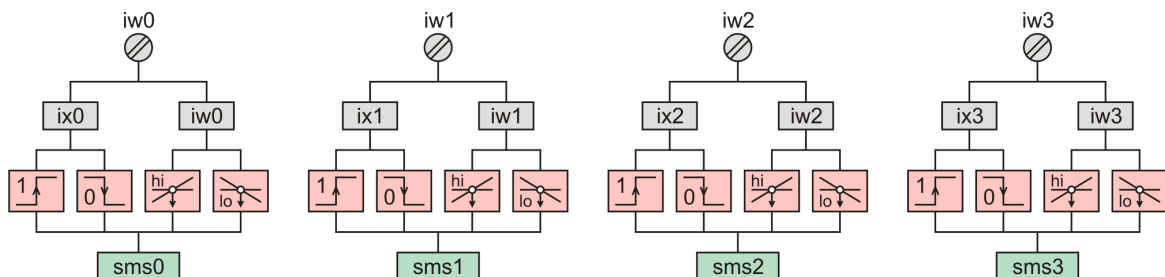

Message is sent to first authorized phone number. Each input act independently of others. Input may trigger both message and outgoing alarm call.

To use alarms, you must authorize your phone. If no phone is authorized, module is not able to send a message.

smsalarm - select inputs which will trigger an alarm:

1	ix0 close	2	ix1 close	4	ix2 close	8	ix3 close
16	ix0 open	32	ix1 open	64	ix2 open	128	ix3 open
256	iw0 hi limit	512	iw1 hi limit	1024	iw2 hi limit	2048	iw3 hi limit
4096	iw0 lo limit	8192	iw1 lo limit	16384	iw2 lo limit	32768	iw3 lo limit

For a combined action, add values together, e.g. 17 will send a message whenever ix0 is changed.

iw0lo, iw1lo, iw2lo, iw3lo - alarm low limit, 0..1023 (default is 0)
iw0hi, iw1hi, iw2hi, iw3hi - alarm high limit, 0..1023 (default is 1023)

Alarm is activated when value is strictly higher or strictly lower (not equal) than limit value.

sms0, sms1, sms2, sms3 - alarm content (default is "Alarm 0", "Alarm 1"...)
hyst - hysteresis, common for all inputs, for both high and low alarms (default is 100)
rearm - after condition is off, time to wait before new activation is possible (default is 600) [seconds]

Alarm is deactivated when value returns below limit and hysteresis:

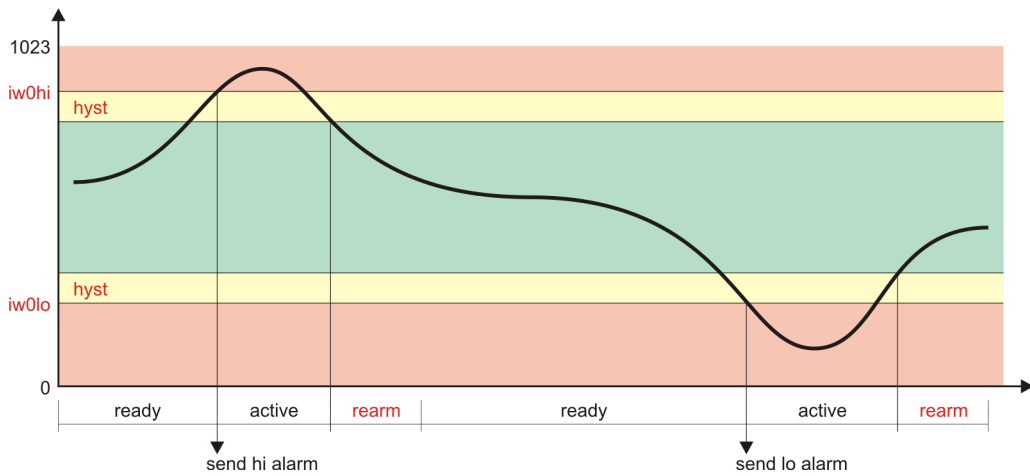

Example 1:

Configure two alarms, one for pump overload, second for low level warning.

Connect pump overload contact (normally open) to ix0. Connect water level measurement (0..10V) to iw1.

Configuration word is 1 (ix0 close) + 8192 (iw1 lo limit) = 8193. Alarm limit is 35cm, full scale is 150cm, so value is $35 \div 150 \times 1023 = 239$.

```
send: smsalarm=8193 iw1lo=239 sms0="Alarm: pump overload" sms1=" Alarm: water low"
reply: smsalarm=8193 ok iw1lo=239 ok sms0="Alarm: pump overload" ok sms1=" Alarm: water low" ok
```

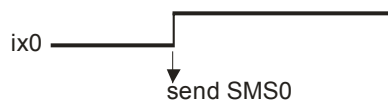

alarm: Alarm: pump overload

Example 2:

To send separate hi and lo messages, wire two inputs together:

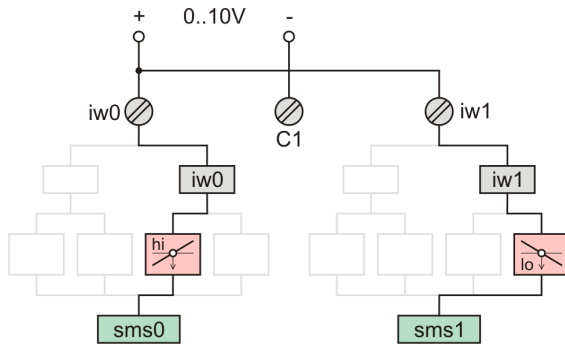

Configuration word is 256 (iw0 hi limit) + 8192 (iw1 lo limit) = 8448.

```
send: smsalarm=8448 iw0hi=850 iw1lo=5 sms0="Alarm: water high" sms1="Alarm: water low"
reply: smsalarm=8448 ok iw0hi=850 ok iw1lo=5 ok sms0="Alarm: water high" ok sms1="Alarm: water low" ok
```

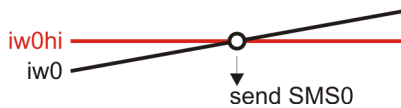

alarm: Alarm: water high

Outgoing alarm call



voicealarm - select inputs which will make a call

1	ix0 close	2	ix1 close	4	ix2 close	8	ix3 close
16	ix0 open	32	ix1 open	64	ix2 open	128	ix3 open
256	iw0 hi limit	512	iw1 hi limit	1024	iw2 hi limit	2048	iw3 hi limit
4096	iw0 lo limit	8192	iw1 lo limit	16384	iw2 lo limit	32768	iw3 lo limit

For a combined action, add values together. Limits and hysteresis are common with message alarm.

```
send: voicealarm=15 rearm=300
reply: voicealarm=15 ok rearm=300 ok
```

Any digital input (1+2+4+8) makes a call. Alarm is armed again after rearm period.

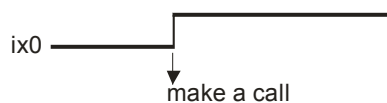

First call goes to first authorized phone number. To confirm a call, press "hang up" button. If not confirmed, module will ring for about 30 seconds, then wait, then ring again. Call is repeated 3 times. Still not confirmed, next call will advance to second authorized number, then third, until alarm is confirmed.

To use alarm call, you must authorize your phone. If no phone is authorized, module is not able to make a call.

Phone authorization



Authorization defines phones allowed to send commands. By default, access is allowed for everybody. Once authorized, commands from other phones will be ignored. Authorized phone is recipient for alarm messages.

allow - add number to list of authorized numbers

```
send: allow +385912345678
reply: allow +385912345678 ok
```

deny - delete number from list of authorized numbers

```
send: deny +385912345678
reply: deny +385912345678 ok
```

allowcall - authorize next incoming call (call must come within 5 minutes)

```
send: allowcall
reply: allowcall +385912345678 ok
error: allowcall timeout
```

check - verify if number is authorized

```
send: check +385912345678
reply: check +385912345678 ok
error: check +385912345678 unknown
```

phones - show all configured phones

```
send: phones
reply: phones=3: +385912345678 +385912222222 +385913333333
```

If longer then 160 characters (SMS size limit), rest won't be displayed.

As with other commands, one SMS may contain multiple requests, e.g. two "allow" and "phones" command.

Settings and status



confirm - enable or disable confirmation messages (0-don't confirm, 1-confirm, default is 1)

```
send: confirm=1
reply: confirm=1 ok
```

ping - connection check

```
send: ping
reply: ping ok
```

status - read status of inputs and outputs, signal strength (0..31), and roaming status (0-domestic, 1-roaming)

```
send: status
reply: qx0=0 qx1=0 ix0=0 ix1=1 ix2=0 ix3=0 iw0=600 iw1=0 iw2=430 iw3=600 signal=27 roaming=0
```

config - check configuration settings

```
send: config
reply: confirm=1 pulse=2 voicecall=0 smsalarm=8193 voicealarm=15 iw0lo=0 iw0hi=1023 iw1lo=0 iw1hi=1023
iw2lo=0 iw2hi=1023 iw3lo=0 iw3hi=1023 hist=100 rearm=600
```

reset - reset all parameters to factory defaults, allow access to everybody

```
send: reset
reply: reset ok
```

Applications

Call garage to open door for you



Knowledge: easy

Usefulness: high (you certainly don't need yet another remote controller)

Cool factor: high (watch your neighbours turn green)

What do you need: garage with motorized door, GSM-SA, SIM card

How to connect: connect wires from QX0 and C0 to button which operate door. Polarity doesn't matter. Don't forget to connect 12V power supply.

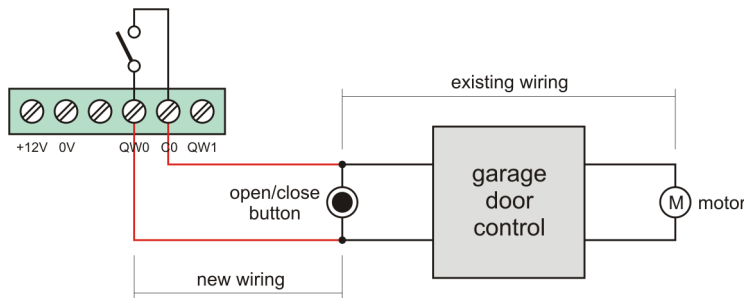

Module configuration:

send: `voicecall=256 allow +385912345678` enter your mobile phone here

Mobile configuration: put GSM-SA on your speed dial.

How to use: press speed dial and lay phone down. Door will open in a few seconds.

Module will deny your call, so action is free of charge. However, prepaid account will require periodic updates, usually from 6 to 12 months. To update, put SIM card into your phone.

Security is high - once configured, nobody will be able to access your module or change configuration.

Other ideas: use the same setup to enter your house.

Activate heating before arriving to cottage



Knowledge: easy

Usefulness: high (even higher if temperature falls below zero)

Cool factor: high (it's quite uncool to spend weekend in a freezing house)

What do you need: heating system with thermostat, GSM-SA, SIM card

How to connect: connect wires from QX0 and C0 in series with your thermostate. Polarity doesn't matter. Don't forget 12V power supply.

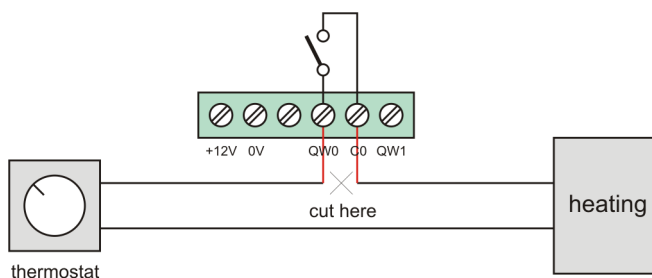

Module configuration:

send: `allow +385912345678` enter your mobile phone here

How to use: send SMS to activate or deactivate heating.

send: qx0=1 to activate heating

send: qx0=0 to deactivate heating

Other ideas: you may equally well connect GSM-SA to control the power supply of heating system.

Secure your property against burglary

Knowledge: moderate

Usefulness: high (hopefully you'll never know how much)

Cool factor: low (good alarm system keeps low profile)

What do you need: few meters of very thin wire, GSM-SA, SIM card

How to connect: run wire across the area you want to secure, connect to IW0 and C1.

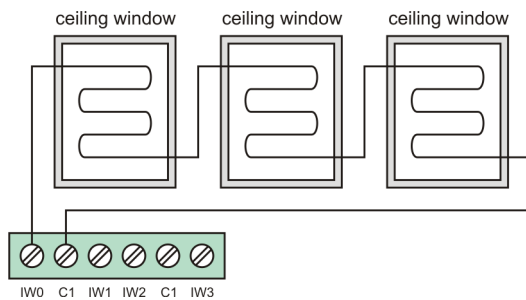

Module configuration:

send: voicealarm=16 smsalarm=16 sms0="Burglar alarm!" allow +385912345678 enter your mobile phone here

How to use: make wiring and leave system on. Check status from time to time:

send: status

Other ideas: Run another wire around your property. Use other inputs to connect PIR sensors.

Water level monitoring and alarm

Knowledge: expert

Usefulness: high (especially for hardly accessible locations)

Cool factor: low (but sharply increase with a number of remote stations)

What do you need: level sensor with 0..10V output, GSM-SA, SIM card

How to connect: connect sensor to analog input.

Module configuration:

send: smsalarm=4096 iw0lo=245 sms0="Tank 1 level too low!" allow +385912345678 enter your mobile phone here

How to use: make wiring and leave system on. Check status regularly:

send: status

Other ideas: If more measurements or control is needed (temperature, flow, touch screen, scada, database), use programmable CyBro-2/GSM-1 system instead. For more details, check <http://www.cybrotech.co.uk>.

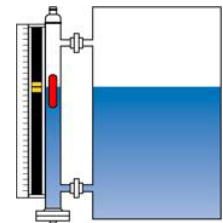

Specifications

GSM module	three-band 900/1800/1900MHz
Antenna	internal or external
Connector	SMA with automatic switch
External antenna	50ohm nominal
Input type	digital / analog 0..10V
Internal pull-up	6V, 1mA
Digital readout	0-open, 1-closed
A/D converter	10-bit
Analog readout	0..1023
Accuracy	5% FSR at 25°C
Output type	relay contact, normally open
Load	max. 3A/250V AC or 3A/30V DC, resistive
Power supply	12V DC (10-16V)
Power consumption	150mA receiving, 200mA transmitting
Operating conditions	0..50°C, 0..85% rh non-condensing
Dimensions	36x99x70mm

Wiring

digital inputs, 12V output

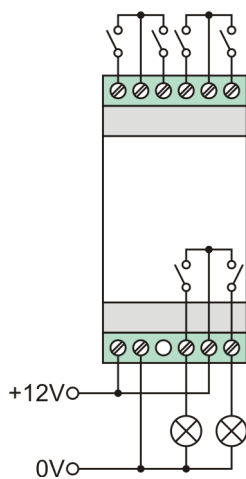

output using 230V contactor

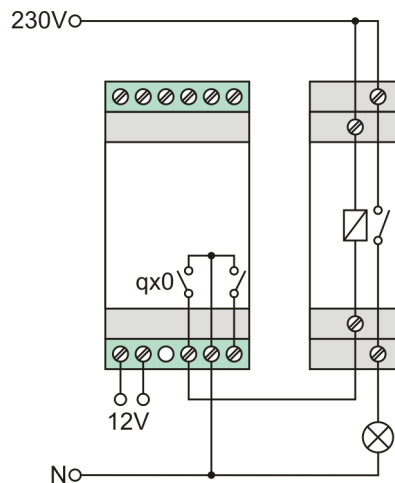

output using 230V bistable relay

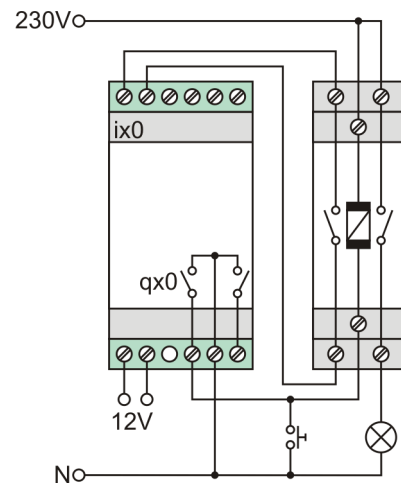

Mounting

When operating on internal antenna, it is recommended to mount GSM-SA away from other electronic devices. Placing as high as possible will provide a better signal, resulting in more stable communication.

Master reset

If module is not accessible for any reason, this procedure will reset to default configuration:

- remove SIM card
- connect iw0 and iw1 to C1, leave iw2 and iw3 open
- power on and wait about 15s, until power led shortly goes off
- power off, insert SIM card and continue normal operation

Parameters are now set to default values, allow list is empty (access allowed for everybody).